

# SceneScan / SceneScan Pro

## User Guide

(v1.18) March 15, 2024



Allied Vision Technologies GmbH  
Taschenweg 2a  
07646 Stadtroda  
Germany

WEEE-Reg.-Nr. DE52901569  
Email: [info@alliedvision.com](mailto:info@alliedvision.com)  
[www.alliedvision.com](http://www.alliedvision.com)

---

# Contents

<b>1</b>	<b>Functionality Overview</b>	<b>4</b>
<b>2</b>	<b>SceneScan / SceneScan Pro Differences</b>	<b>4</b>
<b>3</b>	<b>Included Parts</b>	<b>4</b>
<b>4</b>	<b>General Specifications</b>	<b>5</b>
4.1	Hardware Details . . . . .	5
4.2	Stereo Matching . . . . .	5
4.3	Frame Rates and Resolutions . . . . .	6
<b>5</b>	<b>Mechanical Specifications</b>	<b>6</b>
5.1	Dimensions . . . . .	6
5.2	Mounting . . . . .	6
<b>6</b>	<b>Physical Interfaces</b>	<b>8</b>
6.1	Interface Overview . . . . .	8
6.2	Power Supply . . . . .	9
6.3	Trigger Port . . . . .	9
6.4	Configuration Reset Button . . . . .	10
<b>7</b>	<b>Hardware Setup</b>	<b>11</b>
7.1	Basic Setup . . . . .	11
7.2	Networking Configuration . . . . .	11
7.2.1	IP Configuration . . . . .	11
7.2.2	Jumbo Frames . . . . .	12
7.3	Supported Cameras . . . . .	14
7.4	Color Camera Considerations . . . . .	14
7.5	Camera Setup . . . . .	14
7.6	Focus Adjustment . . . . .	15
7.7	Aperture Adjustment . . . . .	16
7.8	Other Image Sources . . . . .	17
7.9	External Trigger . . . . .	17
7.10	Time Synchronization Signal . . . . .	18
<b>8</b>	<b>Processing Results</b>	<b>18</b>
8.1	Rectified Images . . . . .	18
8.2	Disparity Maps . . . . .	18
8.3	3D Point Clouds . . . . .	20
8.4	Timestamps and Sequence Numbers . . . . .	21

---

<b>9</b>	<b>Configuration</b>	<b>22</b>
9.1	System Status . . . . .	22
9.2	Presets . . . . .	23
9.3	Preview . . . . .	23
9.4	Camera Selection . . . . .	25
9.5	Acquisition Settings . . . . .	26
9.5.1	Simple Camera Settings . . . . .	26
9.5.2	Trigger Rate / Frame Rate . . . . .	28
9.5.3	Exposure Control . . . . .	28
9.6	Camera Calibration . . . . .	28
9.6.1	Calibration Board . . . . .	28
9.6.2	Constraining the image size for calibration . . . . .	30
9.6.3	Recording Calibration Frames . . . . .	31
9.6.4	Performing Calibration . . . . .	31
9.7	Network Settings . . . . .	32
9.8	Output Channels . . . . .	34
9.9	Maintenance . . . . .	35
9.10	Processing Settings . . . . .	36
9.10.1	Operation Mode . . . . .	36
9.10.2	Disparity Settings . . . . .	37
9.10.3	Algorithm Settings . . . . .	37
9.11	Advanced Camera Settings . . . . .	39
9.12	Advanced Auto Exposure and Gain Settings . . . . .	41
9.12.1	Exposure and Gain . . . . .	41
9.12.2	Manual Settings . . . . .	42
9.12.3	ROI Settings . . . . .	42
9.13	Trigger / Pairing . . . . .	42
9.14	Time Synchronization . . . . .	44
9.15	Reviewing Calibration Results . . . . .	45
9.16	Auto Re-calibration . . . . .	47
9.17	Region of Interest . . . . .	48
<b>10</b>	<b>API Usage Information</b>	<b>49</b>
10.1	General Information . . . . .	49
10.2	ImageTransfer Example . . . . .	50
10.3	AsyncTransfer Example . . . . .	52
10.4	3D Reconstruction . . . . .	53
10.5	Parameters . . . . .	53
<b>11</b>	<b>Supplied Software</b>	<b>53</b>
11.1	NVCom . . . . .	53
11.2	GenICam GenTL Producer . . . . .	54
11.2.1	Installation . . . . .	54
11.2.2	Virtual Devices . . . . .	56
11.2.3	Device IDs . . . . .	56

---

11.3 ROS Node . . . . .	57
<b>12 Support</b>	<b>57</b>
<b>13 Warranty Information</b>	<b>58</b>
<b>14 Open Source Information</b>	<b>58</b>

## 1 Functionality Overview

SceneScan and SceneScan Pro (both referred as “SceneScan” in this document) are embedded image processing systems for real-time stereo matching. SceneScan connects to a dedicated stereo camera or two industrial USB cameras, which are mounted at slightly different viewing positions. By correlating the image data from both cameras, SceneScan can infer the depth of the observed scene. The computed depth map is transmitted through gigabit Ethernet to a connected computer or another embedded system.

In combination with the cameras, SceneScan is a complete 3D sensor system.

In contrast to conventional solutions, however, SceneScan works passively. This means that no light needs to be emitted for performing measurements. This makes SceneScan particularly robust towards the illumination conditions, and it facilitates long-range measurements, the use of multiple sensors with overlapping field of views, and a flexible reconfiguration of the system for different measurement ranges.

For measuring an object, SceneScan requires visible surface texture. If a surface is completely uniform, a texture projector is required. A suitable texture projector is available as an accessory from Nerian Vision Technologies.

## 2 SceneScan / SceneScan Pro Differences

Two different models exist for the given image processing system: SceneScan and SceneScan Pro. Both models provide the same functionality, however, SceneScan Pro has significantly more computational power when compared to SceneScan. This means that SceneScan Pro can process a given input stereo image much faster than SceneScan.

Thanks to the additional processing power, SceneScan Pro is also capable of processing higher image resolutions, color images and larger disparity ranges. Due to these benefits, SceneScan Pro can achieve a higher measurement accuracy than SceneScan. Table 1 contains a brief comparison between SceneScan and SceneScan Pro. A detailed comparison of the achievable frame rates at different image resolutions and disparity ranges can be found in Section 4.3 on page 6.

## 3 Included Parts

The following parts should be included when ordering a new SceneScan device from Allied Vision:

- SceneScan / SceneScan Pro processing system

Table 1: Comparison between SceneScan and SceneScan Pro.

	SceneScan	SceneScan Pro
<b>Max. resolution</b>	0.6 MP (for 1:1 ratio) 0.5 MP (for 4:3 ratio)	6.2 MP (for 1:1 ratio) 5.3 MP (for 4:3 ratio)
<b>Max. disparity</b>	128 pixels	256 pixels
<b>Max. frame rate</b>	45 fps	135 fps
<b>Supported image types</b>	monochrome	monochrome / color

- 12 V DC power supply with interchangeable mains connectors for Europe, North America, United Kingdom and Australia
- Printed user manual
- Calibration board in A4 size
- Ethernet cable, 3 m

If any of these items re missing, then please contact customer support.

## 4 General Specifications

### 4.1 Hardware Details

<b>Power supply</b>	11 - 14 V DC
<b>Power consumption</b>	Less than 10 W without supplying camera power Up to 20 W with supplying camera power
<b>Dimensions</b>	104.5 × 105.5 × 45 mm without mounting brackets 104.5 × 130 × 45 mm with mounting brackets
<b>Weight</b>	400 g
<b>I/O</b>	2× USB 3.0 host, gigabit ethernet, GPIO
<b>Max. USB power</b>	900 mA
<b>Operating temperature</b>	0°C to 45°C
<b>Conformity</b>	CE, FCC, UKCA, RoHS

### 4.2 Stereo Matching

<b>Stereo algorithm</b>	Variation of Semi-Global Matching (SGM)
<b>Max. resolution</b>	SceneScan (1:1 ratio): 800 × 800 pixels SceneScan (4:3 ratio): 800 × 600 pixels SceneScan Pro (1:1 ratio): 2496 × 2496 pixels SceneScan Pro (4:3 ratio): 2659 × 2000 pixels
<b>Supported pixel formats</b>	Mono8, Mono12, Mono12p, Mono12Packed, RGB8 <sup>1</sup> BayerGR8 <sup>1</sup> , BayerRG8 <sup>1</sup> , BayerGB8 <sup>1</sup> , BayerBG8 <sup>1</sup>

<sup>1</sup>SceneScan Pro only.

<b>Disparity range</b>	SceneScan: 64 to 128 pixels SceneScan Pro: 96 to 256 pixels (32 pixels increment)
<b>Frame rate</b>	SceneScan: up to 45 fps SceneScan Pro: up to 135 fps
<b>Sub-pixel resolution</b>	4 bits (1/16 pixel)
<b>Post-processing</b>	Consistency check, uniqueness check, gap interpolation, noise reduction, speckle filtering

### 4.3 Achievable Frame Rates and Image Resolutions

The maximum frame rate that can be achieved depends on the image size and the configured disparity range. Table 2 provides a list of recommended configurations. This is only a subset of the available configuration space. Differing image resolutions and disparity ranges can be used to meet specific application requirements.

## 5 Mechanical Specifications

### 5.1 Dimensions

Figures 1a and 1b show SceneScan as seen from the front and from the side. The provided dimensions are measured in millimeters.

### 5.2 Mounting

The casing of SceneScan features two mounting brackets to the sides of the device. Each mounting bracket has two slotted holes, which allows SceneScan to be mounted onto a flat surface. The dimensions and placement of the mounting brackets are depicted in Figure 2. In order to support heat dissipation, it **is recommended to mount the device onto a surface made of metal** or another material with a high heat conductivity.

Table 2: Maximum frame rate by image resolution and disparity range for SceneScan and SceneScan Pro.

Model	Disparity Range	Image Resolution				
		640×480	800×592	1024×768	1600×1200	2032×1536
<b>SceneScan</b> monochrome	64 pixels	45 fps	30 fps	n/a	n/a	n/a
	128 pixels	30 fps	20 fps	n/a	n/a	n/a
<b>SceneScan Pro</b> monochrome	128 pixels	135 fps	90 fps	55 fps	22 fps	13 fps
	256 pixels	75 fps	53 fps	34 fps	12 fps	7 fps
<b>SceneScan Pro</b> color	128 pixels	80 fps	53 fps	32 fps	13 fps	8 fps
	256 pixels	72 fps	49 fps	32 fps	12 fps	7 fps

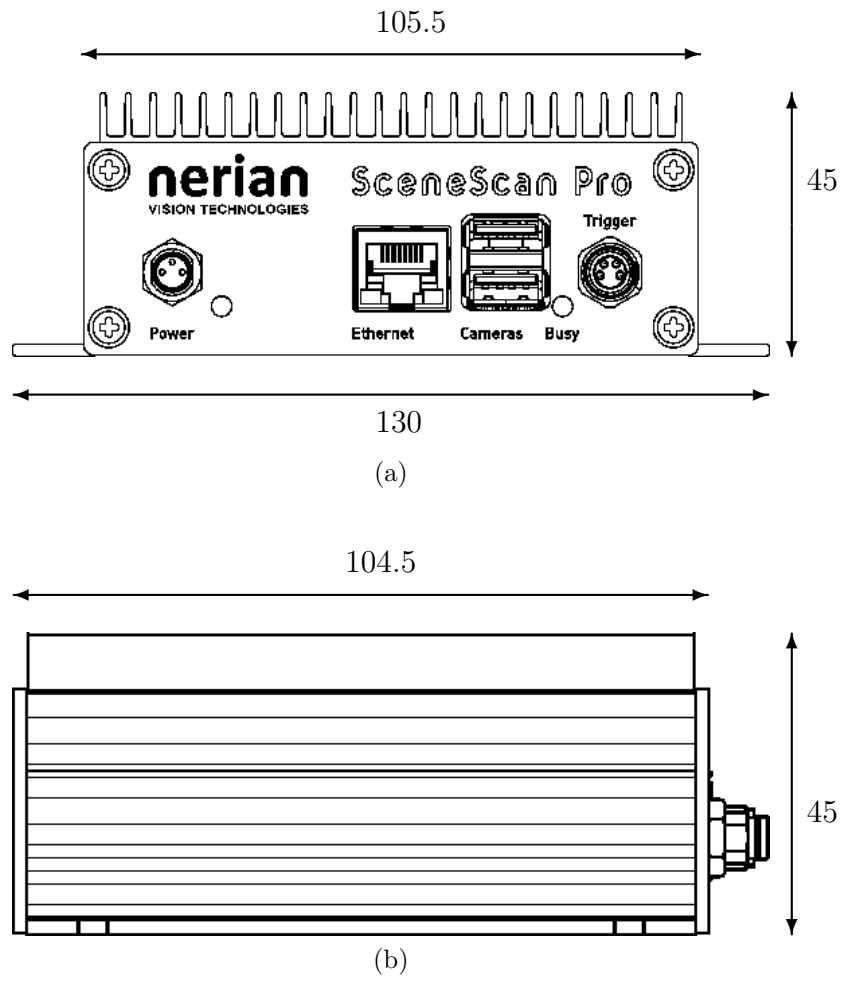

Figure 1: (a) Front and (b) side view of SceneScan with dimensions in millimeters.



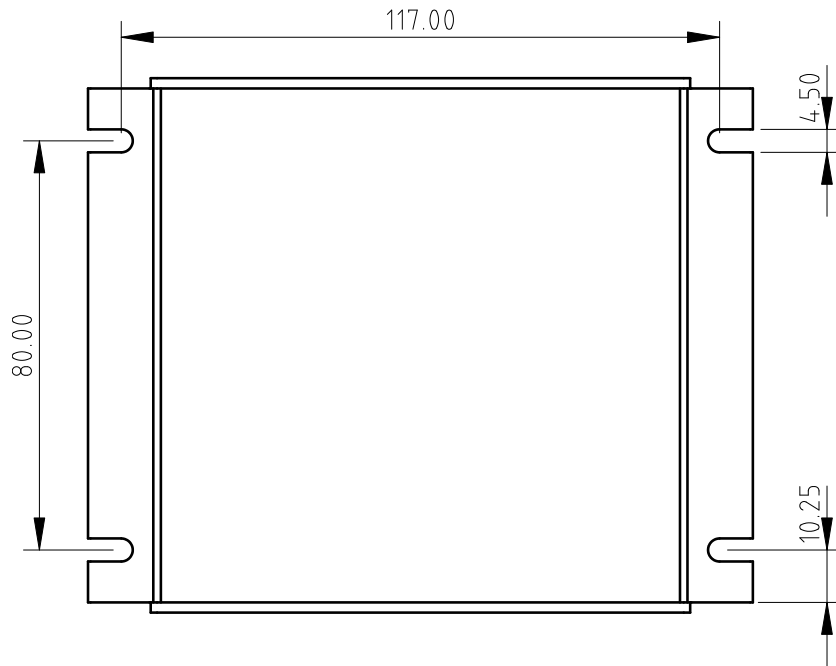

Figure 2: Dimensions of SceneScan mounting brackets.

## 6 Physical Interfaces

### 6.1 Interface Overview

Figures 3a and 3b show the interfaces on SceneScan’s front and backside. These interfaces are:

**Power connector:** Connects to a power supply within the permitted voltage range.

**Power LED:** Indicates that the device is powered up and running.

**Ethernet port:** Port for connecting SceneScan to a client computer or another embedded system. This port is used for delivering processing results and for providing access to the configuration interface.

**USB ports:** Ports for connecting SceneScan to up to two USB cameras. The maximum supply current of each port is 900 mA.

**Busy LED:** Indicates that the device is currently processing image data.

**Trigger port:** Provides a pulse signal for triggering both cameras. Also functions as an input for the time synchronization pulse.

**Reset button:** Button for resetting the device configuration back to the default state.

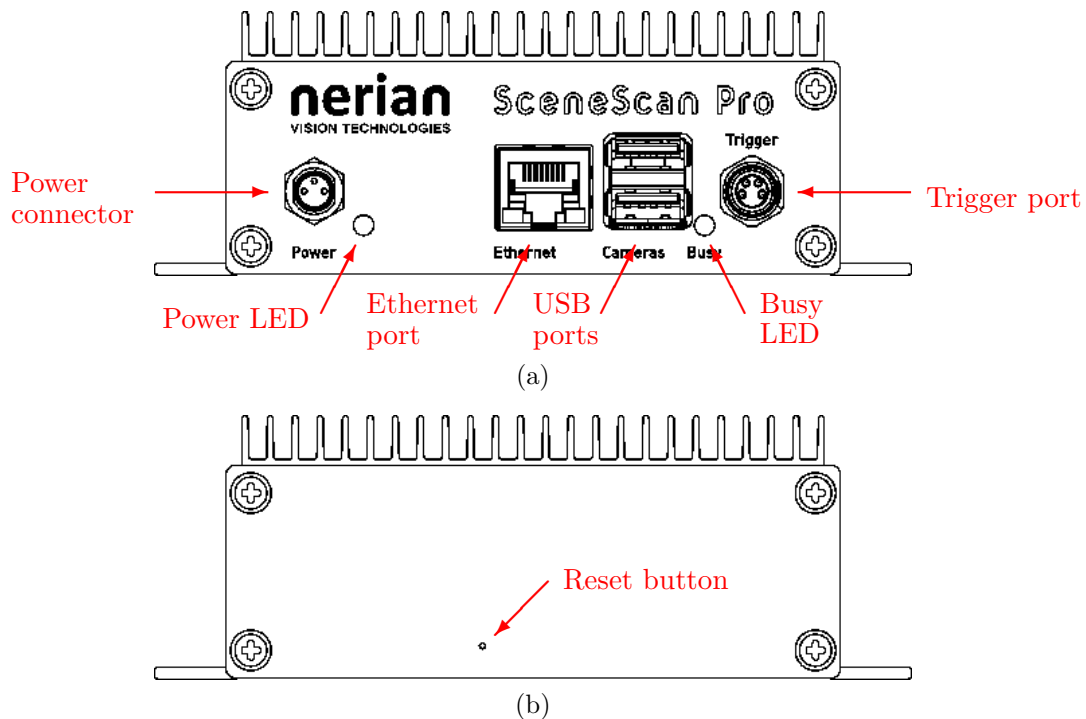

Figure 3: Interfaces on (a) front and (b) rear housing side.

## 6.2 Power Supply

The power connector needs to be connected to the supplied power adapter or an equivalent model. When using an alternative power supply, please make sure that the voltage is in the permitted range of 11 - 14 V DC. Higher voltages might damage the device. A power supply with a maximum output current of at least 2 A is recommended, in order to supply sufficient power to the cameras (up to 900 mA on each USB port). If the cameras consume less than the permitted maximum current, or are powered externally, then a smaller power supply can be used.

The power connector uses a male 3 pin Binder 718/768 series connector. The pin assignment is shown in Figure 4. The following manufacturer part numbers correspond to matching connectors, and should be used for custom power supplies:

- 99 3400 00 03** Matching connector with solder termination.
- 99 3400 100 03** Matching connector with screw termination.
- 99 3400 550 03** Matching connector with cutting clamps termination.

## 6.3 Trigger Port

The trigger is a signal that is sent to the stereo camera pair. At the moment the signal is received, both cameras synchronously acquire an image. The trigger

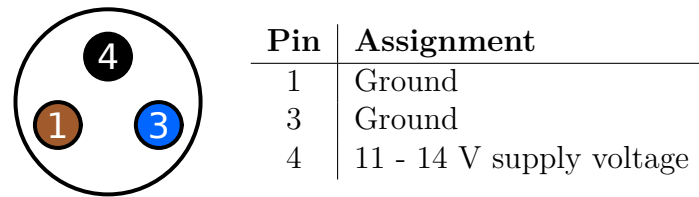

Figure 4: Pin assignment of power connector.

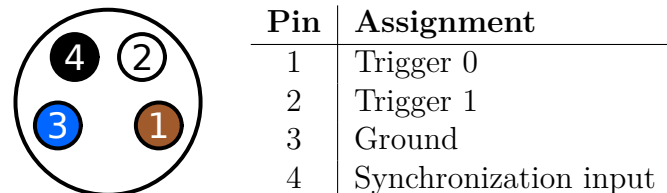

Figure 5: Pin assignment of trigger connector.

port can provide up to two +3.3 V pulse signals. The same port is also used for time synchronization through a synchronization pulse. The pin assignment is shown in Figure 5. Please refer to Sections 7.9 and 7.10 for further details on trigger and synchronization signals.

The trigger connector uses a female 4 pin Binder 718/768 series connector. The following manufacturer part numbers correspond to matching connectors, and should be used for custom trigger cables:

<b>99 3383 00 04</b>	Matching connector with solder termination, not shielded.
<b>99 3383 100 04</b>	Matching connector with screw termination, not shielded.
<b>99 3383 500 04</b>	Matching connector with cutting clamps termination, not shielded.
<b>99 3363 00 04</b>	Matching connector with solder termination, shielded.
<b>99 3363 100 04</b>	Matching connector with screw termination, shielded.

## 6.4 Configuration Reset Button

On the backside of the device is a hidden button that resets the stored configuration to the defaults. This button can be pressed by inserting a pin in the hole and pushing gently. The button needs to be pressed for at least 3 seconds immediately after the device is powered on. Please note that a configuration reset will also reset the network configuration. After a reset, the device will hence respond to the default IP address 192.168.10.10, unless a DHCP server in the network assigns a different address. A configuration reset should be performed if the device becomes unresponsive due to a misconfiguration.

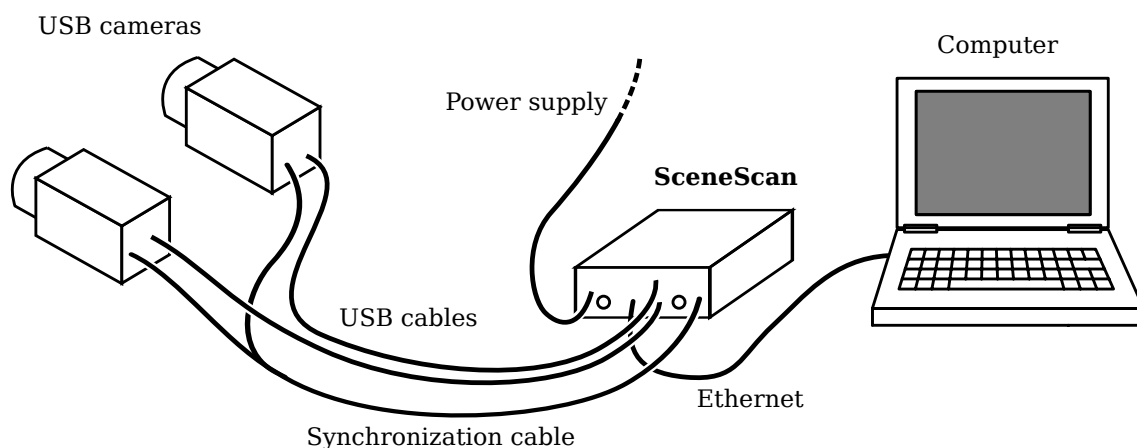

Figure 6: Example setup for cameras, SceneScan and client computer.

## 7 Hardware Setup

### 7.1 Basic Setup

Figure 6 shows a basic system setup for stereo vision. A client computer that receives the computed depth data is connected to SceneScan’s ethernet port. Two cameras are connected to the two available USB ports. As an alternative, it is possible to connect Allied Vision’s dedicated Karmin2 and Karmin3 stereo cameras to one USB port.

The image acquisition of both cameras must be synchronized. SceneScan will only process frames with a matching time stamp. **Operating the cameras in free-run mode will thus result in dropped frames and erroneous results for non-static scenes.** In a typical configuration, synchronization requires connecting the cameras to SceneScan’s trigger port (see Section 7.9), but it is also possible to use other external trigger sources.

### 7.2 Networking Configuration

It is recommended to connect SceneScan directly to the host computer’s ethernet port, without any switches or hubs in between. This is because SceneScan produces very high-throughput network data, which might lead to packet loss when using network switches that cannot meet the required performance. It must be ensured that the host computer’s network interface can handle an incoming data rate of 900 MBit/s.

The necessary network configuration settings for the host computer are described in the following subsections.

#### 7.2.1 IP Configuration

By default, SceneScan will use the IP address 192.168.10.10 with subnet mask 255.255.255.0. If a DHCP server is present on the network, however, it might

assign a different address to SceneScan. In this case please use the provided NVCom software for discovering the device (see Section 11.1).

If no other DHCP server is present on the network, SceneScan will start its own DHCP server. This means that if your computer is configured to use a dynamic IP address the computer will automatically receive an IP address in the correct subnet and no further configuration is required.

If your computer is not configured to use a dynamic IP address or SceneScan's integrated DHCP server is disabled, then you need to configure your IP address manually. For Windows 10 please follow these steps:

1. Click Start Menu > Settings > Network & Internet > Ethernet > Change adapter options.
2. Right-click on the desired Ethernet connection.
3. Click 'Properties'
4. Select 'Internet Protocol Version 4 (TCP/IPv4)'.
5. Click 'Properties'.
6. Select 'Use the following IP address'.
7. Enter the desired IP address (192.168.10.xxx).
8. Enter the subnet mask (255.255.255.0).
9. Press OK.

For Linux, please use the following commands to temporarily set the IP address 192.168.10.xxx on network interface eth0:

```
sudo ifconfig eth0 192.168.10.xxx netmask 255.255.255.0
```

### 7.2.2 Jumbo Frames

**For maximum performance, SceneScan should be configured to use Jumbo Frames** (see Section 9.7). By default, Jumbo Frame support might not be enabled in the shipped configuration, as this requires an appropriate configuration of the host computer's network interface.

If SceneScan is accessible via the web interface and discovered in the devices list (e.g. in NVCom, see Section 11.1), but no image data is received (0 fps), this might indicate that Jumbo Frames are activated in SceneScan, but the network connection of the respective client computer is not properly configured to accept them.

In order to activate Jumbo Frame support in Windows 10, please follow these steps:

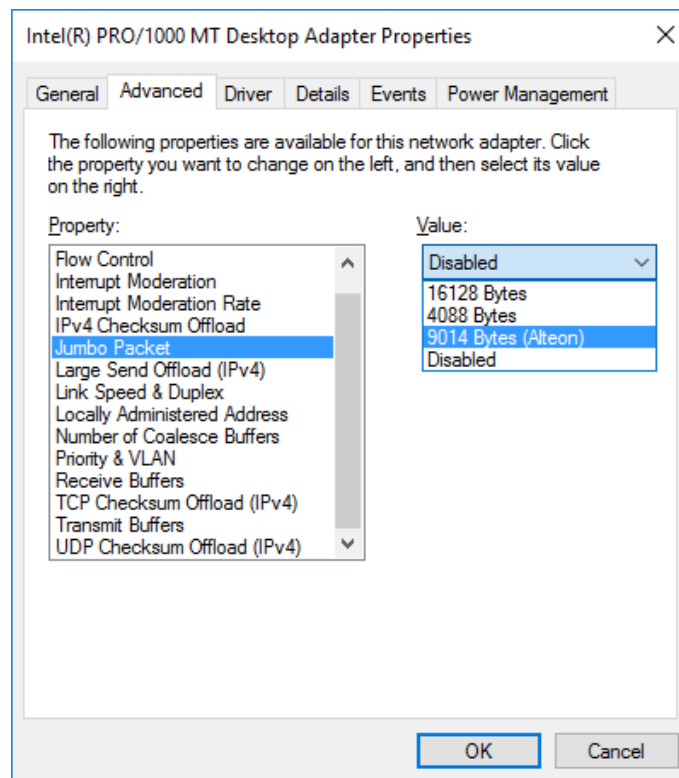

Figure 7: Jumbo Frames configuration in Windows

1. Open 'Network and Sharing Center'
2. Open the properties dialog of the desired network connection
3. Press the button 'Configure...'
4. Open the 'Advanced' tab
5. Select 'Jumbo Packet' and choose the desired packet size (see Figure 7)

Please note that unlike for Linux, some Windows network drivers also count the 14-byte Ethernet header as part of the packet size. **When configuring SceneScan to use a 9000 bytes MTU, a Windows computer might require a 9014 bytes packet size.**

On Linux, Jumbo Frame support can be activated by setting a sufficiently large MTU, through the `ifconfig` command. For configuring a 9000 bytes MTU for interface `eth0`, please use the following command line:

```
> sudo ifconfig eth0 mtu 9000
```

Please be aware that the interface name might be different from `eth0`, especially in newer Linux releases.

The MTU is assigned automatically according to the SceneScan Jumbo Frame settings whenever a Linux computer receives configuration from an



Figure 8: Example for valid stereo camera setup.

active SceneScan DHCP server (see Section 9.7). On Windows, automatic MTU assignment does not work, as Windows does not support this feature.

### 7.3 Supported Cameras

SceneScan supports the USB3 Vision standard. This should allow all USB3 Vision compatible cameras to be used with a monochrome or color sensor. However, to ensure compatibility, we recommend using Allied Vision’s Karmin3 stereo camera or cameras by Allied Vision.

### 7.4 Color Camera Considerations

While SceneScan is limited to grayscale cameras, SceneScan Pro also supports color cameras. It should be noted that **results from grayscale cameras typically outperform the results from color cameras at equal resolutions**. When using color cameras, SceneScan can process an RGB or Bayer pattern image. The use of the RGB format is preferred for maximum performance with current firmwares.

### 7.5 Camera Setup

Both cameras must have an exactly parallel viewing direction. They must be mounted on a plane with a displacement that is perpendicular to the cameras’ optical axes. Furthermore, both cameras must be equipped with lenses that have identical focal lengths. An example for a valid camera setup is shown in Figure 8.

The distance between both cameras is referred to as *baseline distance*. Using a large baseline distance improves the depth resolution at higher distances. A small baseline distances, on the other hand, allows for the observation of close objects. The baseline distance should be adjusted in conjunction with the lenses’ focal length. An tool for computing desirable combinations of baseline distance and focal length can be found online<sup>2</sup>.

<sup>2</sup><https://nerian.com/support/calculator/>

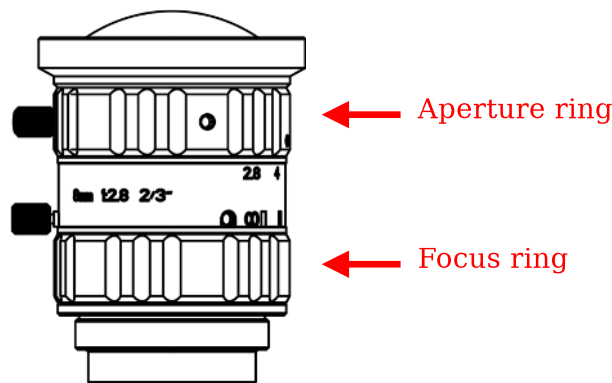

Figure 9: Aperture and focus ring on a typical lens.

## 7.6 Focus Adjustment

When setting up SceneScan it's important to accurately adjust the lens focus for the intended measurement distance. The focus can be adjusted most accurately by using the Siemens star pattern that is printed on the backside of the supplied calibration board.

For adjusting the focus, please mount the stereo camera in the intended orientation. Then place the Siemens star at the position where you want to measure, and examine the recorded image data. This can be done by opening the calibration web interface (see Section 9.6) or the supplied NVCom software (see Section 11.1). You should zoom in to the center of the pattern, which can be done in the web interface by just hovering your mouse over it.

Once you see the center magnified, you can begin adjusting the lens' focus ring. The order of the lens adjustment rings differs with lens models. An example for a typical lens is shown in Figure 9. Please check which ring is which on the lenses you are using. The focus ring should have one position labeled with  $\infty$ .

The focus can be most accurately adjusted when the aperture is in the largest setting (i.e. the **smallest** f-number as printed on the aperture ring). Once the focus has been adjusted, you can set the aperture back to the desired setting.

Turn the focus ring until the star segments in the center are best visible. An example of a well-focused and a poorly focused lens are shown in Figure 10. Once you have found the optimal focus position please fasten the thumb screw to preserve this setting. **Because for most lenses adjusting the focus also slightly affects the focal length (known as lens breathing), the focus of both lenses should not be adjusted after the cameras have been calibrated.** Otherwise, a re-calibration is recommended in order to provide optimal measurements. Please follow the calibration instructions from Section 9.6.



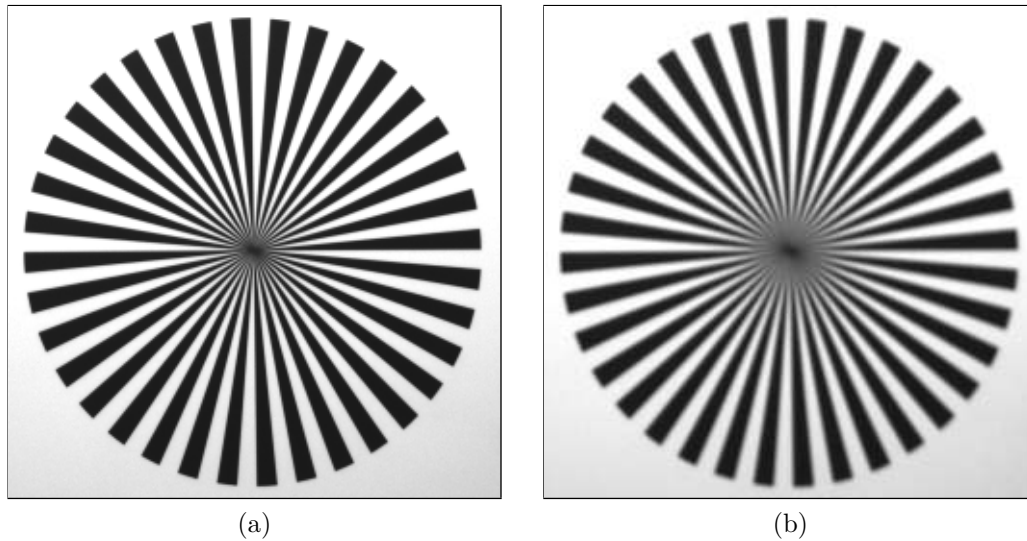

Figure 10: A Siemens star recorded with (a) a well focused lens and (b) a poorly focused lens.

## 7.7 Aperture Adjustment

Once the focus has been adjusted you can adjust the aperture. The smaller the aperture (i.e the **larger** the f-number on the aperture ring) the wider is the *depth of field*. Depth of field refers to the distance between the closest and farthest object that are still acceptably sharp.

Hence, for image sharpness a small aperture is desirable. A small aperture, however, greatly reduces the amount of light reaching the image sensor. This can lead to a high amount of image noise, or force you to use long exposure times that can lead to significant motion blur.

Setting the aperture is thus a compromise between image sharpness, image noise and motion blur. The aperture should be small enough (i.e. the f-number should be large enough) such that the image has an acceptable sharpness. At the same time the aperture should be large enough such that the image sensor does not need to apply a signal gain (i.e. gain is set to 0) or an excessively long exposure time.

When the scene is very bright due to bright lights or outdoors on a bright day, smaller aperture settings are acceptable. The same is true if you are able to use long exposure times due to a low frame rate and a mostly static scene. To help you with choosing a good aperture setting, Allied Vision's online calculator<sup>3</sup> can calculate the depth of field for a particular camera configuration.

Once the aperture is set, please again fasten the thumb screw. Unlike for the focus, a re-calibration is not required when adjusting the aperture.

<sup>3</sup><https://nerian.com/support/calculator/>

## 7.8 Other Image Sources

SceneScan can also process image data that does not originate from real cameras. To allow for an easy evaluation, each device ships with an example stereo sequence on its internal memory. This example sequence appears as two *virtual cameras* that can be selected during camera configuration (see Section 9.4). If selected, the example sequence is replayed in an infinite loop. Due to speed limitations of the internal memory, the example sequence is not replayed at the full frame rate during the first loop iteration.

Another set of virtual cameras provide the ability to receive image data over the ethernet port. In this case a computer has to transmit a set of image pairs to SceneScan, and it then receives the processing results back over the same network. Please note that this significantly increases the required network bandwidth. The bandwidth usage can be reduced by transferring image data at a lower frame rate. **It is highly recommended to always use TCP as underlying network protocol when performing network transfer of input imagery**, in order to avoid dropped frames (see Section 9.7).

The NVCom client application that is described in Section 11.1 can be used for transferring a set of locally stored images to SceneScan. This can be achieved by pressing the appropriate button in the toolbar and selecting a directory with a collection of image files. The image files in this directory are then transmitted in alphabetical order. Please make sure that image files for the left camera always appear before their right camera counter parts when sorted alphabetically.

## 7.9 External Trigger

For stereo matching, it is important that both cameras are synchronized, meaning that both cameras record an image at exactly the same point of time. Many industrial cameras already feature the ability to synchronize themselves, by having one camera produce a trigger signal for the respective other camera.

As an alternative, SceneScan can produce up to two trigger signals. The signals are provided through the trigger port, which is described in Section 6.3. The peak voltage of both trigger signals is at +3.3 V and a maximum current of 24 mA can be supplied. The polarity of the trigger signals is active high.

For exact timing measurements, it is recommended that the cameras trigger on the rising signal edge. The pulse width and frequency can be adjusted in the trigger configuration (see Section 9.13).

If a new USB camera is plugged in, SceneScan will automatically activate the external trigger mode and select the first available trigger line. This might not match your trigger wiring. Hence, changing the camera's trigger settings might be required (see Section 9.5.1).

## 7.10 Time Synchronization Signal

As described in Section 6.3, one pin of the trigger port is dedicated to a time synchronization signal. If PPS time synchronization is activated in the device configuration (see Section 9.14), the internal clock is set to 0 whenever a rising signal edge is received on this pin. In order to trigger a synchronization, the signal must have a voltage level of at least 0.7 V. The maximum allowed voltage is 5.5 V.

Clock synchronization is useful when interpreting the timestamps that are embedded in the transmitted processing results (see Section 8.4). The synchronization input can be connected to the Pulse-Per-Second (PPS) output of a GPS receiver or a precision oscillator, in which case the clock is reset once per second. This allows for the reconstruction of high-precision timestamps on the computer receiving SceneScan's processing results.

As an alternative to synchronizing to an external signal, SceneScan can also perform a clock synchronization through the Network Time Protocol (NTP) or Precision Time Protocol (PTP), as described in Section 9.14.

# 8 Processing Results

## 8.1 Rectified Images

Even when carefully aligning both cameras, you are unlikely to receive images that match the expected result from an ideal camera geometry. The images are affected by various distortions that result from errors in the cameras' optics and mounting. Therefore, the first processing step that is performed is an image undistortion operation, which is known as *image rectification*.

Image rectification requires precise knowledge of the camera setup's projective parameters. These can be determined through camera calibration. Please refer to Section 9.6 for a detailed explanation of the camera calibration procedure.

Figure 11a shows an example camera image, where the camera was pointed towards a calibration board. The edges of the board appear slightly curved, due to radial distortions caused by the camera's optics. Figure 11b shows the same image after image rectification. This time, all edges of the calibration board appear perfectly straight.

In its default configuration, SceneScan additionally outputs the rectified left camera image when performing stereo matching. This allows for a mapping of features in the visible image to structures in the determined scene depth and vice versa.

## 8.2 Disparity Maps

The stereo matching results are delivered in the form of a *disparity map* from the perspective of the left camera. The disparity map associates each pixel in

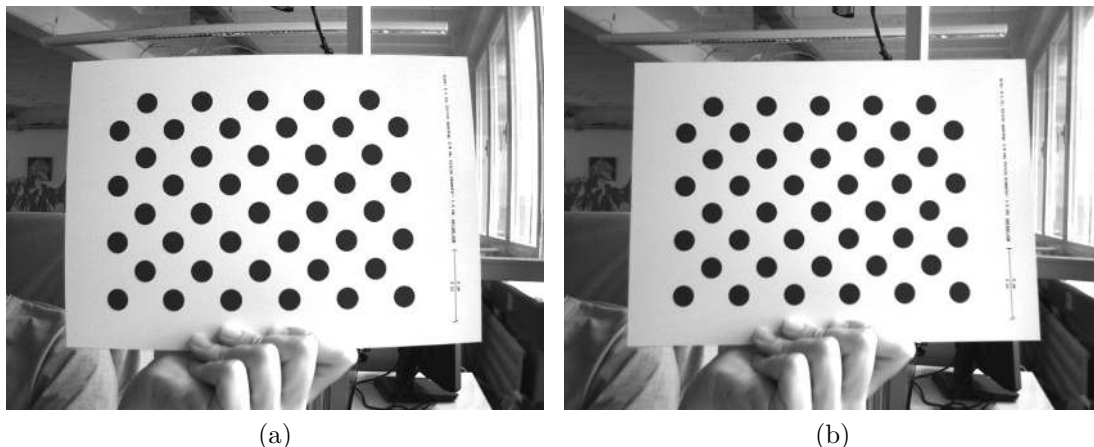

Figure 11: Example for (a) unrectified and (b) rectified camera image.

the left camera image with a corresponding pixel in the right camera image. Because both images were previously rectified to match an ideal stereo camera geometry, corresponding pixels should only differ in their horizontal coordinates. The disparity map thus only encodes a *horizontal coordinate difference*.

Examples for a left camera image and the corresponding disparity map are shown in Figures 12a and 12b. Here the disparity map has been color coded, with blue hues reflecting small disparities, and red hues reflecting large disparities. As can be seen, the disparity is proportional to the inverse depth of the corresponding scene point.

The *disparity range* specifies the image region that is searched for finding pixel correspondences. A large disparity range allows for very accurate measurements, but causes a high computational load, and thus lowers the achievable frame rate. SceneScan supports a configurable disparity range (see Section 9.10), which allows the user to choose between high-precision or high-speed measurements.

SceneScan computes disparity maps with a disparity resolution that is below one pixel. Disparity maps have a bit-depth of 12 bits, with the lower 4 bits of each value representing the fractional disparity component. **It is thus necessary to divide each value in the disparity map by 16, in order to receive the correct disparity magnitude.**

SceneScan applies several post-processing techniques in order to improve the quality of the disparity maps. Some of these methods detect erroneous disparities and mark them as invalid. Invalid disparities are set to `0xFF`, which is the highest value that can be stored in a 12-bit disparity map. In the example disparity map from Figure 12b, invalid disparities are depicted as grey.

Please note that there is usually a stripe of invalid disparities on the left image border of a disparity map. This behavior is expected as the disparity map is computed from the perspective of the left camera. Image regions on

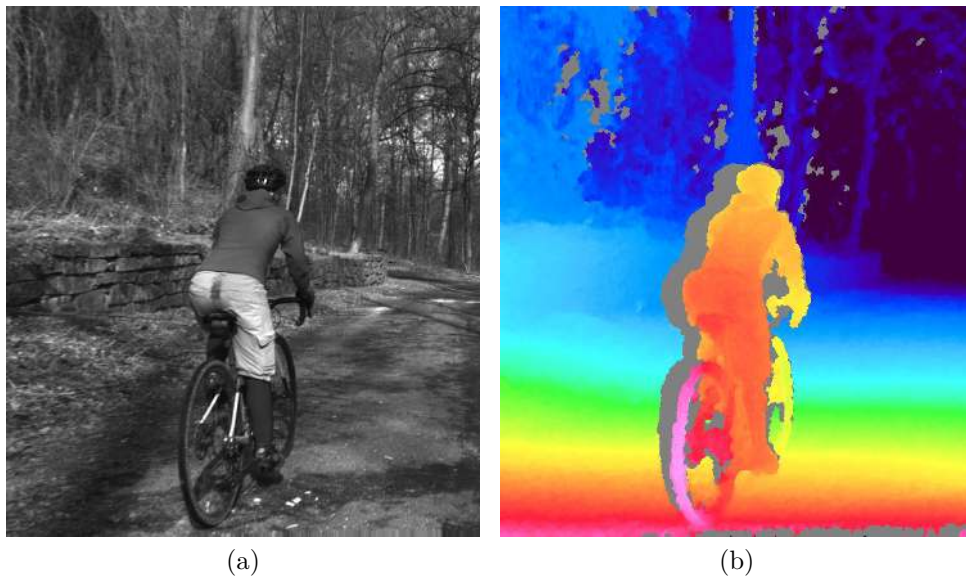

Figure 12: Example for (a) left camera image and corresponding disparity map.

the left edge of the left camera image cannot be observed by the right camera, and therefore no valid disparity can be computed. The farther left an object is located, the farther away it has to be, in order to also be visible to the right camera. Hence, the full depth range can only be observed for left image pixels with a horizontal image coordinate  $u \geq d_{max}$ .

Likewise, invalid disparities can be expected to occur to the left on any foreground object. This shadow-like invalid region is caused by the visible background being occluded in the right camera image but not in the left camera image. This effect is known as the *occlusion shadow* and is clearly visible in the provided example image.

### 8.3 3D Point Clouds

It is possible to transform the disparity map into a set of 3D points. This can be done at a correct metric scale if the system has been calibrated properly. The transformation of a disparity map into a set of 3D points requires knowledge of the disparity-to-depth mapping matrix  $Q$ , which is computed during camera calibration and transmitted by SceneScan along with each disparity map. The 3D location  $(x \ y \ z)^T$  of a point with image coordinates  $(u, v)$  and disparity  $d$  can be reconstructed as follows:

$$\begin{pmatrix} x \\ y \\ z \end{pmatrix} = \frac{1}{w} \cdot \begin{pmatrix} x' \\ y' \\ z' \end{pmatrix}, \text{ with } \begin{pmatrix} x' \\ y' \\ z' \\ w \end{pmatrix} = Q \cdot \begin{pmatrix} u \\ v \\ d \\ 1 \end{pmatrix}$$

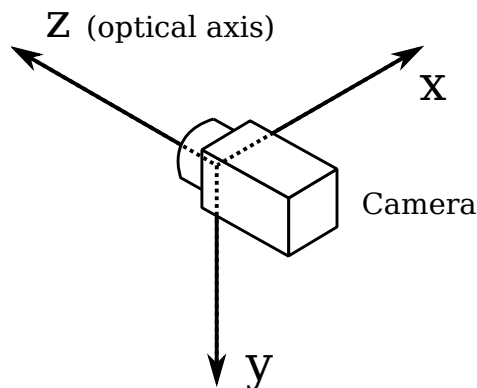

Figure 13: Coordinate system used for 3D reconstruction.

An efficient implementation of this transformation is provided with the available API (see Section 10.4).

When using the  $Q$  matrix provided by SceneScan, the received coordinates will be measured in meters with respect to the coordinate system depicted in Figure 13. Here, the origin matches the lens' center of projection (the location of the aperture in the pinhole camera model) for the left camera.

## 8.4 Timestamps and Sequence Numbers

Each set of images that is transmitted by SceneScan, also includes a timestamp and a sequence number. The timestamp is measured with microsecond accuracy and is set to either the time at which a camera trigger signal was generated or the time at which a frame was received from the cameras (see Section 9.13). For images that are received over the network, as described in Section 7.8, the timestamp and the sequence number are both copied.

As explained in Sections 7.10 and 9.14, it is possible to synchronize SceneScan's internal clock to an external signal or a time server. This directly affects the produced time stamps. When synchronized to a time server, time stamps are measured in microseconds since 1 January 1970, 00:00:00 UTC. If no synchronization is performed, the internal clock is set to 0 at powered up. When synchronizing to an external PPS signal, as explained in Section 7.10, the clock is set to 0 on the incoming rising signal edge.

Please note that synchronizing to a PPS signal also produces negative timestamps. This happens when a synchronization signal is received while SceneScan is processing an already captured image pair, or while SceneScan is waiting for a frame corresponding to an already generated trigger signal. The negative timestamp is then the time difference between the reception of the synchronization signal and the time of capturing or triggering the current image pair.

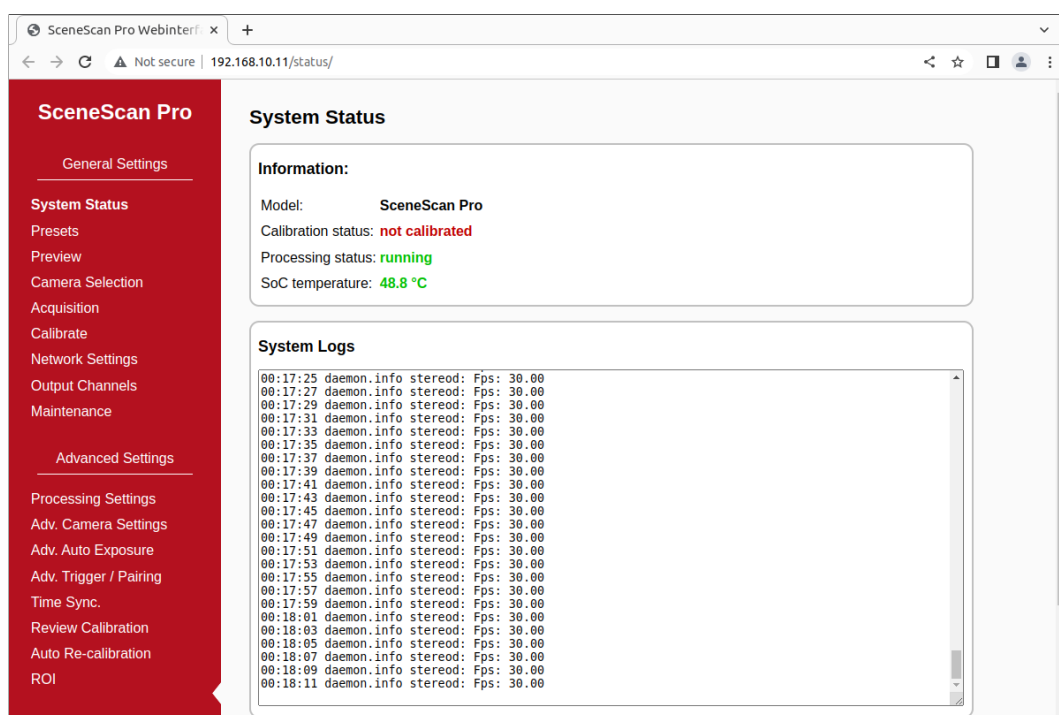

Figure 14: Screenshot of configuration status page.

## 9 Configuration

SceneScan is configured through a web interface, which can be reached by entering its IP address into your browser. The default address is `http://192.168.10.10` but if a DHCP server is present on the network, it might assign a different address to SceneScan (see Section 7.2.1). In this case please use the provided NVCom software for discovering the device (see Section 11.1).

If SceneScan has just been plugged in, it will take several seconds before the web interface is accessible. **For using the web interface, you require a browser with support for HTML 5.** Please use a recent version of one of the major browsers, such as Chrome, Firefox, Safari, or Edge.

The web-interface is divided into two sections: *General Settings* and *Advanced Settings*. The general settings pages contain the most commonly adjusted parameters. Modifying only these parameters should be sufficient for most applications. Less commonly adjusted parameters that might be relevant for very specific applications can be found on the advanced settings pages.

### 9.1 System Status

The first page that you see when opening the web interface is the *'system status'* page that is shown in Figure 14. On this page, you can find the following information:

**Model:** Indicates whether the device is a SceneScan or SceneScan Pro model.

**Calibration status:** Provides information on whether the system has been correctly calibrated. Please be aware that some configuration changes can reset the calibration.

**Processing status:** Indicates whether the image processing sub-system has been started. If this is not the case, then there might be a problem accessing the cameras, or a system error might have occurred. Please consult the system logs in this case. The image processing sub-system will be started immediately once the cause of error has been resolved.

**SOC temperature:** The temperature of the central System-on-Chip (SoC) that performs all processing tasks. The maximum operating temperature for the employed SoC is at 85 °C. A green-orange-red color-coding is applied to signal good, alarming and critical temperatures.

**System logs:** List of system log messages sorted by time. In regular operation, you will find information on the current system performance. In case of errors, the system logs contain corresponding error messages.

## 9.2 Presets

Different configuration presets are available in case SceneScan is used with one of Nerian's Karmin2 or Karmin3 stereo cameras. The use of a preset is highly recommended when working with one of these stereo cameras. For third-party cameras, configuration presets are not available.

Figure 15 shows the *presets* web-interface page. Loading a preset will only modify the parameters that are relevant for a given configuration. Other parameters will not be modified. If all parameters should be set to the preferred default value, it is recommended to first perform a configuration reset (see Section 9.9) and then load the desired preset afterwards.

## 9.3 Preview

The *preview* page, which is shown in Figure 16, provides a live preview of the currently computed disparity map. Please make sure that your network connection supports the high bandwidth that is required for streaming video data (see Section 7.2.2). For using the preview page, you require a direct network connection to SceneScan. An in-between proxy server or a router that performs network address translation (NAT) cannot be used.

**When opening the preview page, SceneScan stops transferring image data to any other host.** The transfer is continued as soon as the browser window is closed, the user presses the pause button below the preview area, or if the user navigates to a different page. Only one open instance of the preview page, or any other page that is streaming video data to the browser,



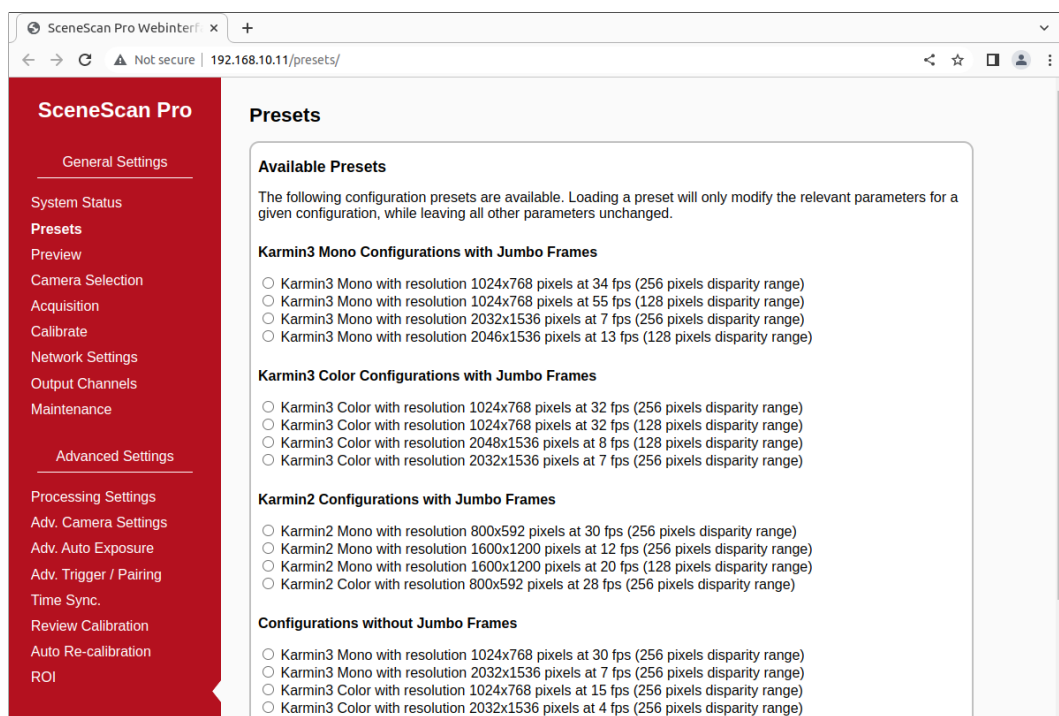

Figure 15: Screenshot of configuration presets page.

is allowed at a time. If attempted to open more than once, only one instance will receive data.

The preview that is displayed in the browser does not reflect the full quality of the computed disparity map. In particular, the frame rate is limited to 20 fps and sub-pixel accuracy is not available. To receive a full-quality preview, please use the NVCom application, which is described in Section 11.1.

Different color-coding schemes can be selected through the drop-down list below the preview area. A color scale is shown to the right, which provides information on the mapping between colors and disparity values. The possible color schemes are:

**Rainbow:** A rainbow color scheme with low wavelengths corresponding to high disparities and high wavelengths corresponding to low disparities. Invalid disparities are depicted in gray.

**Red / blue:** A gradient from red to blue, with red hues corresponding to high disparities and blue hues corresponding to low disparities. Invalid disparities are depicted in black.

**Raw data:** The raw disparity data without color-coding. The pixel intensity matches the integer component of the measured disparity. Invalid disparities are displayed in white.

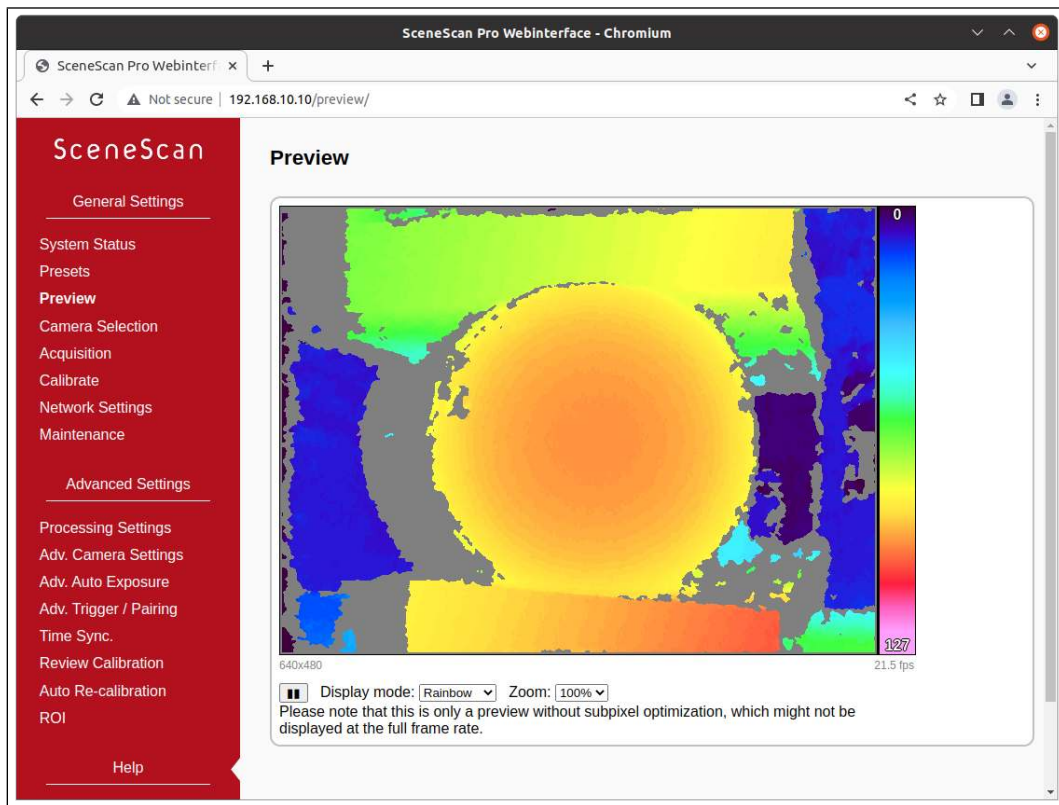

Figure 16: Screenshot of configuration preview page.

## 9.4 Camera Selection

The *camera selection* page that is shown in Figure 17 allows for the selection of a desired stereo camera or camera pair. All detected physical cameras are listed in the ‘*Real Cameras*’ list. In the ‘*Virtual Cameras*’ list there are the two virtual stereo cameras that were mentioned in Section 7.8, which provide an example stereo sequence or facilitate the reception of input images through ethernet.

To select one of Nerian’s Karmin2 or Karmin3 stereo cameras, one needs to tick the ‘*left and right*’ check box. If two separate cameras shall be used instead, one needs to manually select which camera shall be the left and which one the right camera. This ordering must be done from the camera’s perspective. If the left and right cameras are mixed up, this can be automatically detected during camera calibration and the cameras will be automatically reassigned.

Please be aware that changing the camera selection will reset all camera parameters. This also includes the cameras’ calibration data. Hence a re-calibration will be necessary (see Section 9.6).

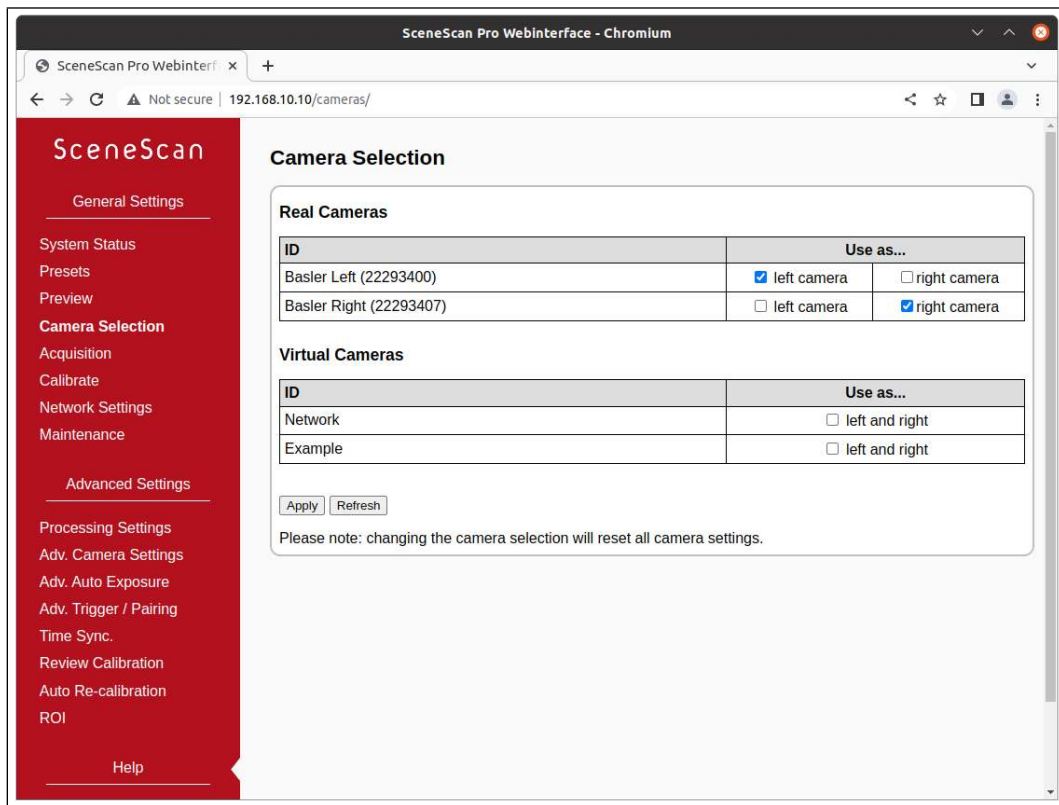

Figure 17: Screenshot of configuration page for camera settings.

## 9.5 Acquisition Settings

The most relevant parameters for image acquisition are listed on the *acquisition settings* page that is shown in Figure 18. This page is divided into three distinct areas.

### 9.5.1 Simple Camera Settings

Settings that are provided by the attached cameras are listed in the *'simple camera settings'* area. Adjusting any of the given parameters will change the configuration for both cameras equally. Please note that the *apply* button must be pressed in order for any configuration changes to become effective. By pressing the *'reset camera defaults'* button, you can reset the cameras' settings to the default configuration. This is usually the configuration that has been written to the cameras' internal memory through the manufacturer software. If the *reset* button is pressed, all configuration changes that have not been confirmed through the *apply* button are reverted.

Exactly which parameters are displayed depends on the connected cameras. For a detailed explanation of these parameters, we thus recommend consulting the camera manufacturer's manual. With a typical stereo camera or individual

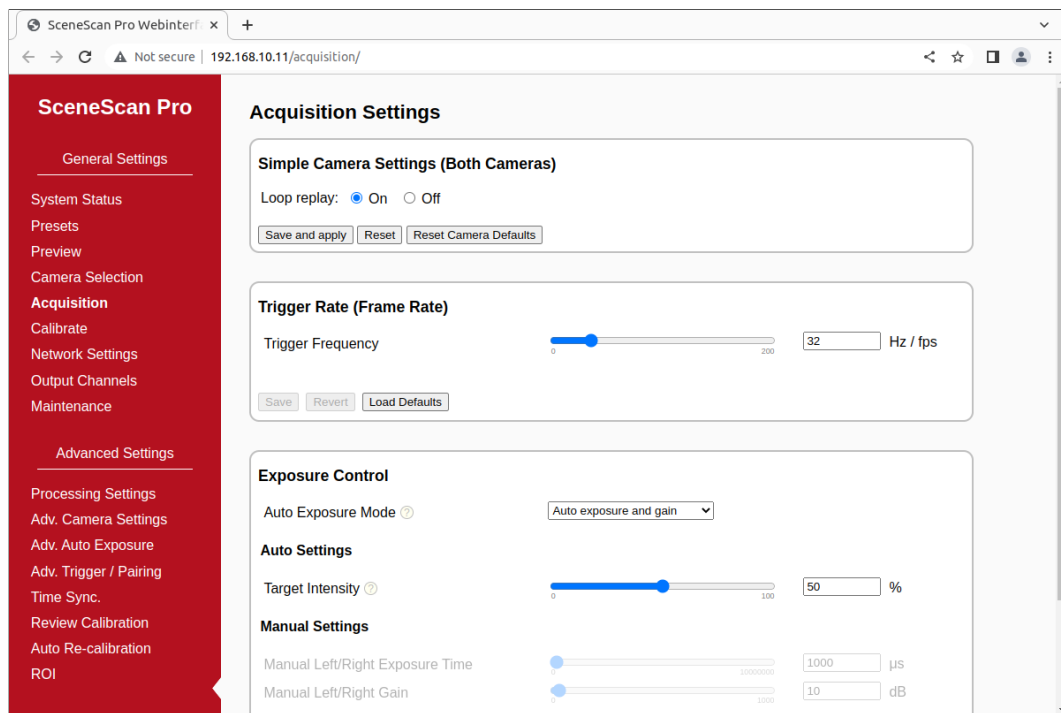

Figure 18: Screenshot of configuration page for acquisition settings.

camera pair, the parameters described below should be available.

### Image Format Control

- Width:** Width in pixels of the selected Region-Of-Interest (ROI). Also see Section 9.17 for more ROI options.
- Height:** Height in pixels of the selected ROI.
- Binning vertical:** Number of vertical photosensitive cells that are combined for one image pixel. There might be conditional dependencies to the *binning horizontal* parameter, which might have to be adjusted first.
- Binning horizontal:** Number of horizontal photosensitive cells that are combined for one image pixel. There might be conditional dependencies to the *binning vertical* parameter, which might have to be adjusted first.
- Pixel format:** Desired pixel encoding mode. For supported formats see Section 4.2.

### Analog Control

- Black level:** Controls the analog black level as an absolute physical

value.  
**Gamma:** Controls the gamma correction of pixel intensity.

### Acquisition Control

**Trigger selector:** Selects the trigger that shall be configured.  
**Trigger mode:** Controls if the selected trigger is active.  
**Trigger source:** Specifies the internal signal or physical input line to use as the trigger source.  
**Trigger activation:** Specifies the activation mode of the trigger.

#### 9.5.2 Trigger Rate / Frame Rate

Cameras that are connected to SceneScan should always be triggered externally (see Section 7.9). Hence the cameras' frame rate settings do not have an effect and should be left at maximum. Rather, the trigger rate should be adjusted in order to control the effective frame rate. This can be done in the '*trigger rate (frame rate)*' area. More detailed trigger options are available on the '*advanced trigger / pairing settings*' page (see Section 9.13), in case a detailed control of the trigger waveform is required.

#### 9.5.3 Exposure Control

SceneScan will automatically control the sensor exposure and gain to match a given average intensity, which can be selected in the '*exposure control*' area. If an automatic adjustment is not desired, then the user can alternatively specify a manual exposure time and gain setting. More advanced exposure and gain options are available on the '*advanced auto exposure and gain settings*' page (see Section 9.12).

## 9.6 Camera Calibration

SceneScan is shipped pre-calibrated if ordered in combination with one of Allied Vision's stereo cameras. However, a re-calibration is necessary if there is any change in the optics (including change of focus) or if there is a mechanical misalignment. In this case the calibration page, which is shown in Figure 19, enables the stereo calibration.

### 9.6.1 Calibration Board

You require a calibration board, which is a flat panel with a visible calibration pattern on one side. The pattern that is used by SceneScan consists of an asymmetric grid of black circles on a white background, as shown in Figure 20.

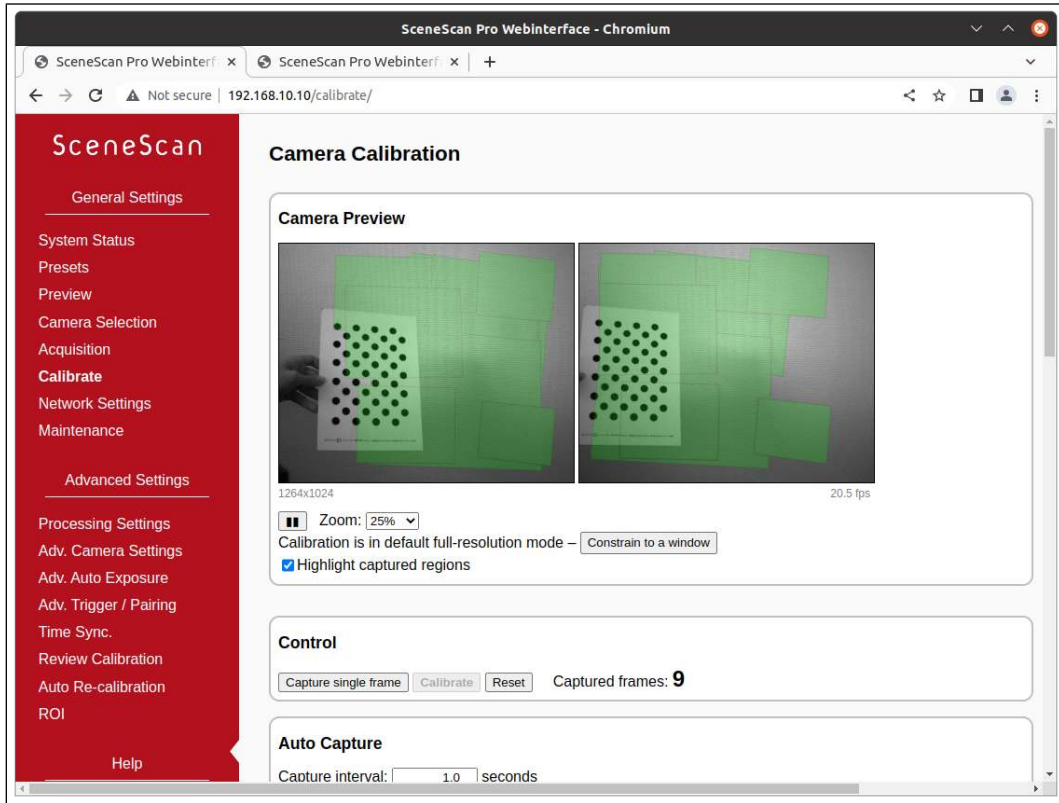

Figure 19: Screenshot of configuration page for camera calibration.

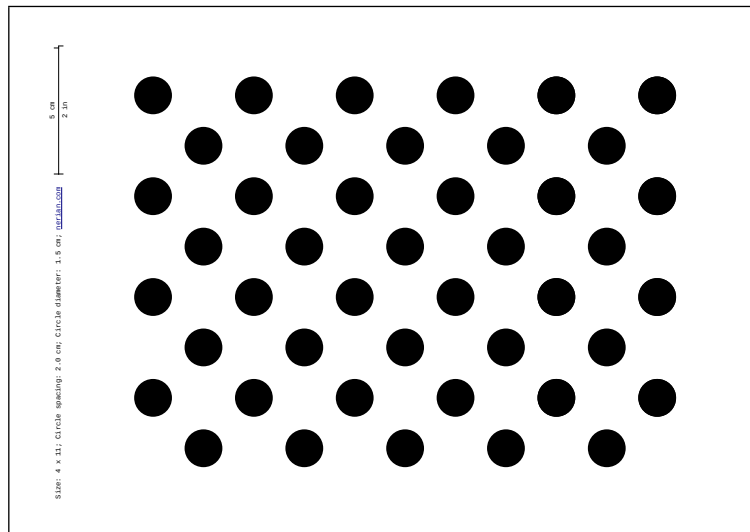

Figure 20: Calibration board used by SceneScan.

When opening the calibration page, you will first need to specify the size of the calibration board, which you are going to use in the calibration process. Please make sure to select the correct size, as otherwise the calibration results cannot be used for 3D reconstruction with a correct metric scale (see Section 8.2).

An A4-sized board is included with SceneScan. The pattern can also be downloaded in other sizes from this page. Simply select the desired pattern size in the ‘*calibration board*’ drop-down list, and click the download link.

Should you require a calibration board with a custom size, then you can select *custom* from the ‘*calibration board*’ drop-down list. This allows you to enter the calibration board details manually. The first dimension of the *pattern size* is the number of circles in one grid column. This number must be equal for all columns of the circles grid.

The number of circles per row is allowed to vary by 1 between odd and even rows. The second dimension is thus the sum of circles in two consecutive rows. All downloadable default calibration patterns have a size of  $4 \times 11$ .

The last parameter that you have to enter when using a custom calibration board is the *circle spacing*. This is the distance between the centers of two neighboring circles. The distance must be equal in horizontal and vertical direction for all circles.

Once the correct board size has been specified, please click on the continue button to proceed with the calibration process.

### 9.6.2 Constraining the image size for calibration

By default, the calibration process will run on the full sensor area, with the maximum valid image size available for the currently active image format and acquisition settings. This is recommended for most setups, since a smaller Region of Interest can be selected at any time post-calibration (see Section 9.17). For special setups, for example if the image circle of a lens is smaller than the image sensor area, it is necessary to constrain the relevant sensor region prior to the initial calibration.

By pressing the ‘*constrain to a window*’ button in the bottom of the ‘*camera preview*’ area, a centered overlay frame is displayed, which can be resized by dragging. If applied, calibration will switch to constrained-region mode. Calibration can be returned to the default operation by pressing the ‘*reset to full-resolution*’ button.

When the calibration process has been successfully completed with a constrained region, this will reduce the default output size (and maximum available Region-of-Interest size) from the maximum valid image size to the selected one, effectively excluding any areas that are outside the calibrated sensor region.

### 9.6.3 Recording Calibration Frames

A live preview of both cameras is displayed in the ‘*camera preview*’ area. Please make sure that you have correctly adjusted the lenses’ focus and aperture as described in Sections 7.6 and 7.7 before you record calibration frames. To check the focus, you can move your mouse cursor over the live preview. This will magnify the image region under the cursor, which allows you to judge the image sharpness more easily.

Unless the calibration region has been constrained as outlined above, the camera resolution during calibration is set to the maximum valid image size for the currently active image format and acquisition settings. Make sure that the calibration board is fully visible in both camera images and then press the ‘*capture single frame*’ button in the *control* section. Repeat this process several times while moving either the camera or the calibration board.

The calibration board must be recorded at multiple different positions and orientations. A green overlay will be displayed in the preview window for all locations, where the board has previously been detected. You should vary the distance of the board and make sure that you cover most of the field of view of both cameras. When recording the calibration frames, it is important that both cameras are synchronized.

The more frames you record, the more accurate the computed calibration will be. However, more frames also cause the computation of the calibration parameters to take longer. SceneScan supports the recording of up to 40 calibration frames. We recommend using at least 20 calibration frames in order to receive accurate results.

The recording of calibration frames can be simplified by activating the ‘*auto capture*’ mode. In this mode, a new calibration frame is recorded in fix *capture intervals*. You can enter the desired interval in the auto capture section and then press the ‘*start auto capture*’ button. If desired, an audible sound can be played to signal the countdown and the recording of a new frame. Auto capture mode can be stopped by pressing the ‘*stop auto capture*’ button.

A small preview of each captured calibration frame is added to the ‘*captured frames*’ section. The frames are overlaid with the detected positions of the calibration board circles. You can click any of the preview images to see the calibration frame at its full resolution. An example for a calibration frame with a correctly detected calibration board is shown in Figure 21. If the calibration board was not detected correctly or if you are unhappy with the quality of a calibration frame, then you can delete it by clicking on the ×-symbol.

### 9.6.4 Performing Calibration

Once you have recorded a sufficient number of calibration frames, you can initiate the calibration process by pressing the *calibrate* button in the *control* section. The time required for camera calibration depends on the number of calibration frames that you have recorded. Calibration will usually take several



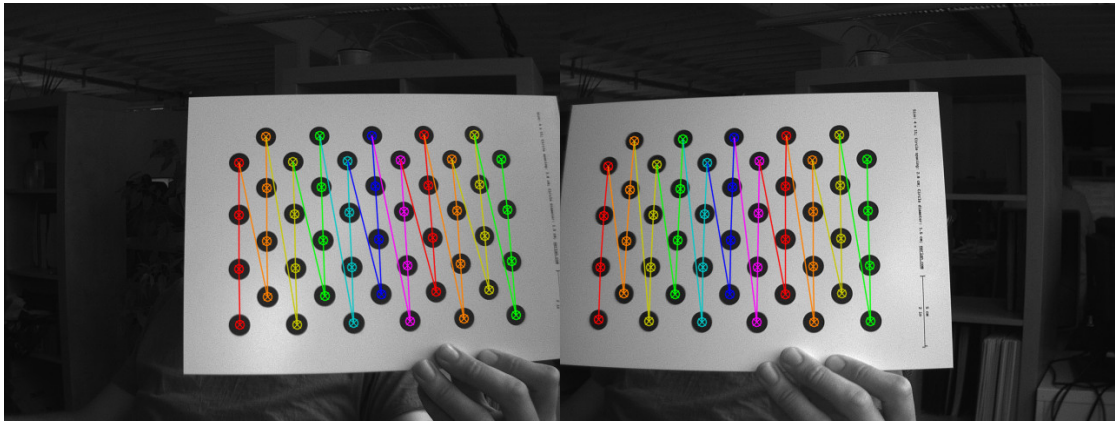

Figure 21: Example calibration frame with detected calibration board.

minutes to complete. If calibration is successful then you are immediately redirected to the *'review calibration'* page.

Calibration will fail if the computed vertical or horizontal pixel displacement exceeds the allowed range for any image point. The most common causes for calibration failures are:

- Insufficient number of calibration frames.
- Poor coverage of the field of view with the calibration board.
- Improperly aligned cameras. See Section 7.5.
- Lenses with strong geometric distortions.
- Lenses with unequal focal lengths.
- Improper camera synchronization.
- Frames with calibration board misdetections.

Should calibration fail, then please resolve the cause of error and repeat the calibration process. If the cause of error is one or more erroneous calibration frames, then you can delete those frames and re-press the *calibrate* button. Likewise, in case of too few calibration frames, you can record additional frames and restart the calibration computation.

## 9.7 Network Settings

The *'network settings'* page, which is displayed in Figure 22, is used for configuring all network related parameters. SceneScan can query the network configuration automatically via DHCP client requests, which are enabled by default to aid switching between existing network setups. SceneScan devices in

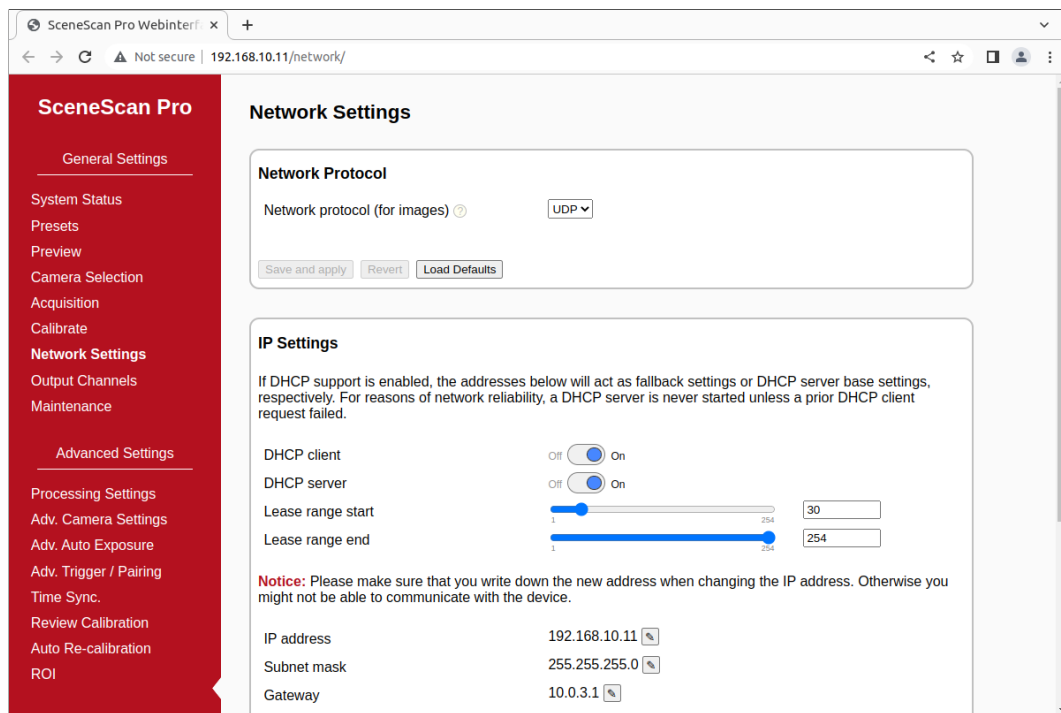

Figure 22: Screenshot of configuration page for network settings.

a network that assigns IP settings through DHCP are easily discovered and accessed via the device discovery API and also the NVCom utility (Section 11.1). If no DHCP servers are present, SceneScan uses its static IP settings as a fallback.

DHCP client support can be disabled if fixed IP settings are desired and the device will not be switched between different networks. In this case, the IP settings in this section are used as static values.

SceneScan also contains a fallback DHCP server. It is enabled by default but only launched when a prior DHCP client request failed. This means that no DHCP server is ever launched if DHCP client support is turned off, to ensure that SceneScan will never compete with an existing DHCP server. The SceneScan DHCP server uses the IP address settings as a base; the lease range is always in the /24 subnet of the IP address.

In the *'IP settings'* section, you can disable or enable the DHCP components and specify an IP address, subnet mask and gateway address, which are used as static configuration or fallback configuration depending on the DHCP settings. When changing the IP settings, please make sure that your computer is in the same subnet, or that there exists a gateway router through which data can be transferred between both subnets. Otherwise you will not be able to access the web interface anymore and you might be forced to perform a configuration reset (see Section 6.4).

In the *'network protocol'* section, you can choose the underlying network

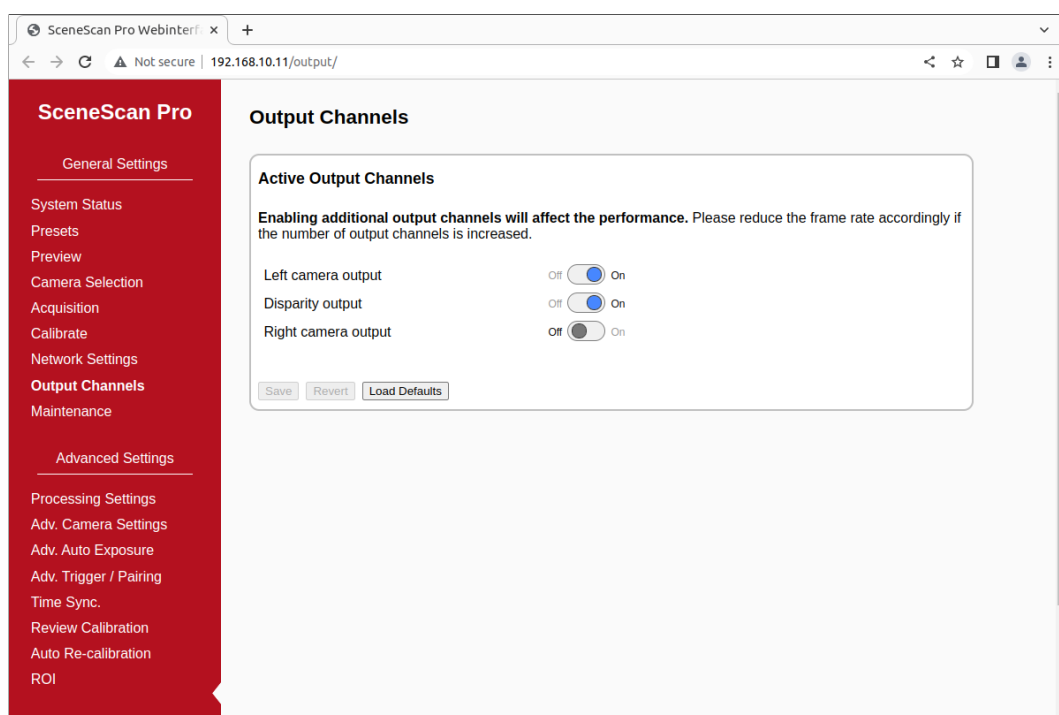

Figure 23: Screenshot of output channels configuration page.

protocol that shall be used for delivering the computation results to the client computer. The possible options are *TCP* and *UDP*. Due to the high-bandwidth real time data we recommend using *UDP*, unless the input images are transferred through ethernet, as described in Section 7.8.

In order to obtain the best possible performance, jumbo frames support should be activated in the ‘*jumbo frames*’ section. Before doing so, however, you must make sure that jumbo frames support is also enabled for your client computer’s network interface. Details on how to enable jumbo frame support on your computer can be found in Section 7.2.2 on page 12. For Linux client computers, the jumbo frames (MTU) setting is automatically applied when receiving configuration from an active SceneScan DHCP server. Please note that in this case changing the SceneScan Jumbo Frames mode or MTU Size necessitates new DHCP leases to propagate the setting (e.g. by unplugging and re-inserting the network cable).

## 9.8 Output Channels

The active output channels can be configured on the ‘*output channels*’ page. An output channel is an image data stream that is transmitted over the network. The following output channels are available:

- Left camera output

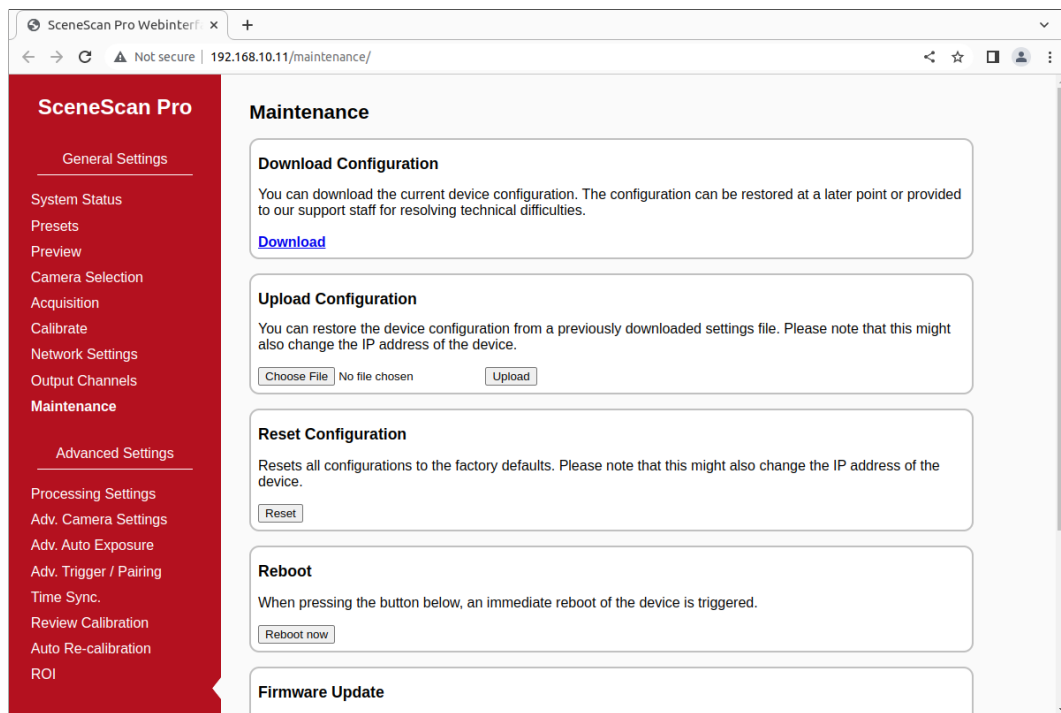

Figure 24: Screenshot of configuration maintenance page.

- Disparity output
- Right camera output

If the operation mode (see Section 9.10) is set to *stereo matching* (the default) or *rectify*, then the image data of all output channels are rectified (see Section 8.1 for details). If the operation mode is set to *pass through*, however, the camera images will be transmitted without modifications.

Please note that increasing the number of active output channels also increases the network load and might result in a reduced frame rate. All performance specifications given in this document refer to a configuration with only the left and disparity output channel activated.

## 9.9 Maintenance

On the *maintenance* page that is shown in Figure 24, you can download a file that contains the current device configuration and the system logs, by pressing the *download* link. In case of technical problems please include this file in your support request, such that your device configuration can be reproduced and that system problems can be investigated.

A downloaded configuration file can be re-uploaded at a later point in time. This allows for a quick switching between different device configurations. In order to upload a configuration, please select the configuration file and press the

*upload* button. Please be aware that uploading a different configuration might modify the IP address of the device. In order to avoid a faulty configuration state, please only upload configurations that have previously been downloaded through the web interface.

If you are experiencing troubles with your current device configuration, you can reset all configuration settings to the factory defaults, by pressing the *reset* button. Please note that this will also reset the network configuration, which might lead to a change of SceneScan's IP address. This is equivalent to pressing the reset button on the backside of the device (see Section 6.4).

If SceneScan shows signs of erroneous behavior, it is possible to reboot the device by pressing the '*reboot now*' button. It will take several seconds until a reboot is completed and SceneScan is providing measurement data again. Please use this function as an alternative to a power cycle, if the device cannot be easily accessed.

The maintenance page further allows you to perform firmware updates. Use this functionality only for firmware files that have officially been released by Nerian Vision Technologies. To perform a firmware update, select the desired firmware file and press the *update* button. The update process will take several seconds. **Do not unplug the device, reload the maintenance page or re-click the update button while performing firmware updates.** Otherwise, this might lead to a corrupted firmware state. Once the update has been completed the device will automatically perform a reboot with the new firmware version. The device configuration is preserved during firmware updates, but some updates might require you to adjust specific settings afterwards.

## 9.10 Processing Settings

### 9.10.1 Operation Mode

The major processing parameters can be changed on the '*processing settings*' page, which is shown in Figure 25. The most relevant option is the operation mode, which can be set to one of the following values:

**Pass through:** In this mode SceneScan forwards the imagery of all cameras without modification. This mode is intended for reviewing the image data before any processing is applied.

**Rectify:** In this mode SceneScan transmits the rectified images of all cameras. This mode is intended for verifying the correctness of the image rectification.

**Stereo matching:** This is the default mode, in which SceneScan performs the actual stereo image processing (stereo matching). SceneScan transmits the disparity map and, depending on the output channels configuration, the rectified images.

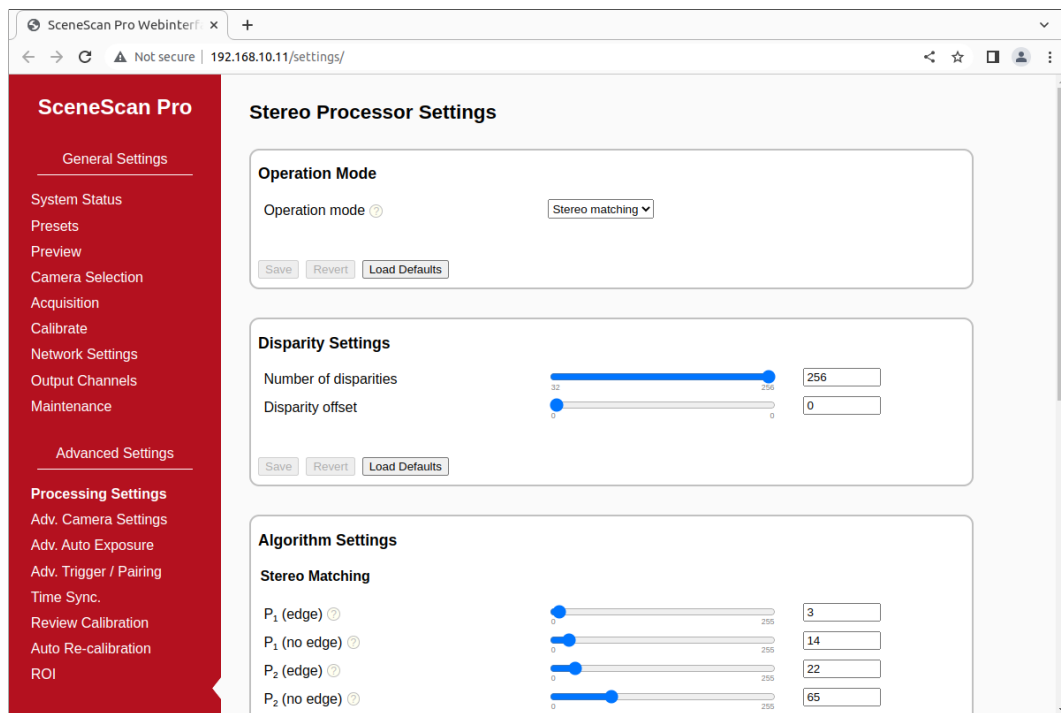

Figure 25: Screenshot of configuration page for processing settings.

### 9.10.2 Disparity Settings

If the operation mode is set to stereo matching, then the ‘*disparity settings*’ allow for a configuration of the disparity range that is searched by SceneScan. The disparity range affects the frame rate that can be achieved. **The frame rate should be adjusted once the disparity range has been changed** (see Section 4.3 on page 6 for recommendations). Please be aware that increasing the disparity range will also reduce the maximum image size that can be configured.

The ‘*number of disparities*’ option specifies the total number of pixels that are searched for correspondences. This option has a high impact on the depth resolution and the covered measurement range (see Section 8.2). The start of the disparity range can be chosen through the ‘*disparity offset*’ option. Typically, a value of 0 is desired for the offset, which allows for range measurements up to infinity. If the observable distance is certain to be constrained, then low disparity values won’t occur. In this case it is possible to increase the disparity offset, such that these low disparities are not computed.

### 9.10.3 Algorithm Settings

The behavior of the image processing algorithms can be controlled through the ‘*algorithm settings*’. The default configuration has been determined using machine learning methods, and it should thus be the best choice for most use

cases. Nevertheless, all algorithm parameters can be adjusted through the web interface. The following parameters control the stereo matching algorithm:

**Penalty for disparity changes ( $P_1$ ):** A penalty that is applied to gradually changing disparities. A large value causes gradual disparity changes to occur less frequently, while a small value causes gradual changes to occur more frequently. Different values can be configured for pixels that are on image edges ( $P_{1-edge}$ ) and pixels that are not on edges ( $P_{1-no-edge}$ ). These values must be smaller than the values for  $P_2$ .

**Penalty for disparity discontinuities ( $P_2$ ):** A penalty that is applied to abruptly changing disparities. A large value causes disparity discontinuities to occur less frequently, while a small value causes discontinuities to occur more frequently. Different values can be configured for pixels that are on image edges ( $P_{2-edge}$ ) and pixels that are not on edges ( $P_{2-no-edge}$ ). These values must be greater than the values for  $P_1$ .

SceneScan applies an optimization algorithm to improve the accuracy of the computed disparity map to sub-pixel resolution. If only a small region of interest (ROI) of the input image / disparity map is relevant, then this auto-tuning process can be constrained to only this ROI. In this case one should expect more accurate sub-pixel measurements inside the ROI. The relevant parameters for constraining the sub-pixel tuning ROI are:

**Tune sub-pixel optimization on ROI:** If enabled, the sub-pixel optimization is tuned on the region defined by the subsequent parameters, instead of the whole image.

**Width:** Width in pixels of the selected Region of Interest (ROI).

**Height:** Height in pixels of the selected ROI.

**Offset X:** Horizontal offset of the ROI relative to the image center.

**Offset Y:** Vertical offset of the ROI relative to the image center.

SceneScan implements several methods for post-processing the computed disparity map. Each post-processing method can be activated or deactivated individually. The available methods are:

**Mask border pixels:** If enabled, this option marks all disparities that are close to the border of the visible image area as invalid, as they have a high uncertainty. This also includes all pixels for which no actual image data is available, due to the warping applied by the image rectification (see Section 8.1).

**Consistency check:** If enabled, stereo matching is performed in both matching directions, left-to-right and right-to-left. Pixels for which the disparity is not consistent are marked as invalid. The sensitivity of the consistency check can be controlled through the ‘*consistency check sensitivity*’ slider.

**Uniqueness check:** If enabled, pixels in the disparity map are marked as invalid if there is no sufficiently unique solution (i.e. the cost function does not have a global minimum that is significantly lower than all other local minima). The sensitivity of the uniqueness check can be controlled through the ‘*uniqueness check sensitivity*’ slider.

**Texture filter:** If enabled, pixels that belong to image regions with little texture are marked as invalid in the disparity map, as there is a high likelihood that these pixels are mismatched. The sensitivity of this filter can be adjusted through the ‘*texture filter sensitivity*’ slider.

**Gap interpolation:** If enabled, small patches of invalid disparities, which are caused by one of the preceding filters, are filled through interpolation.

**Noise reduction:** If enabled, an image filter is applied to the disparity map, which reduces noise and removes outliers.

**Speckle filter iterations:** Marks small isolated patches of similar disparity as invalid. Such *speckles* are often the result of erroneous matches. The number of iterations specify how aggressive the filter will be with removing speckles. A value of 0 disables the filter.

## 9.11 Advanced Camera Settings

More advanced camera parameters can be adjusted on the ‘*advanced camera settings*’ page, which is shown in Figure 26. This page provides two separate configuration areas, one for the left camera and one for the right camera, which can be adjusted individually.

Most machine vision cameras provide a large number of parameters that can be adjusted. In order to keep the configuration manageable, the parameters are sorted into different visibility groups. The visibility group can be changed through the drop-down list in the top right corner of each configuration area. By default the *Beginner* visibility group is selected, which only contains the most basic features. In order to view more advanced settings, please select the *Expert* or *Guru* visibility group.

For an explanation of the various parameters, please refer to the documentation from your camera manufacturer.



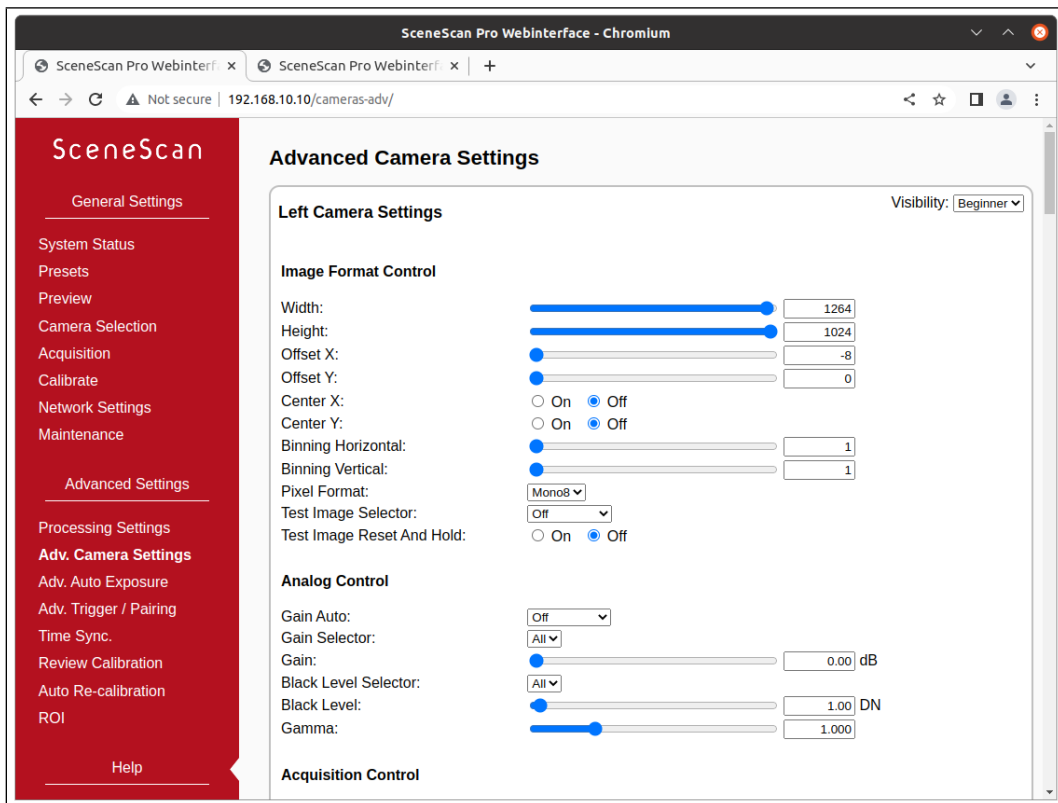

Figure 26: Screenshot of configuration page for advanced camera settings.

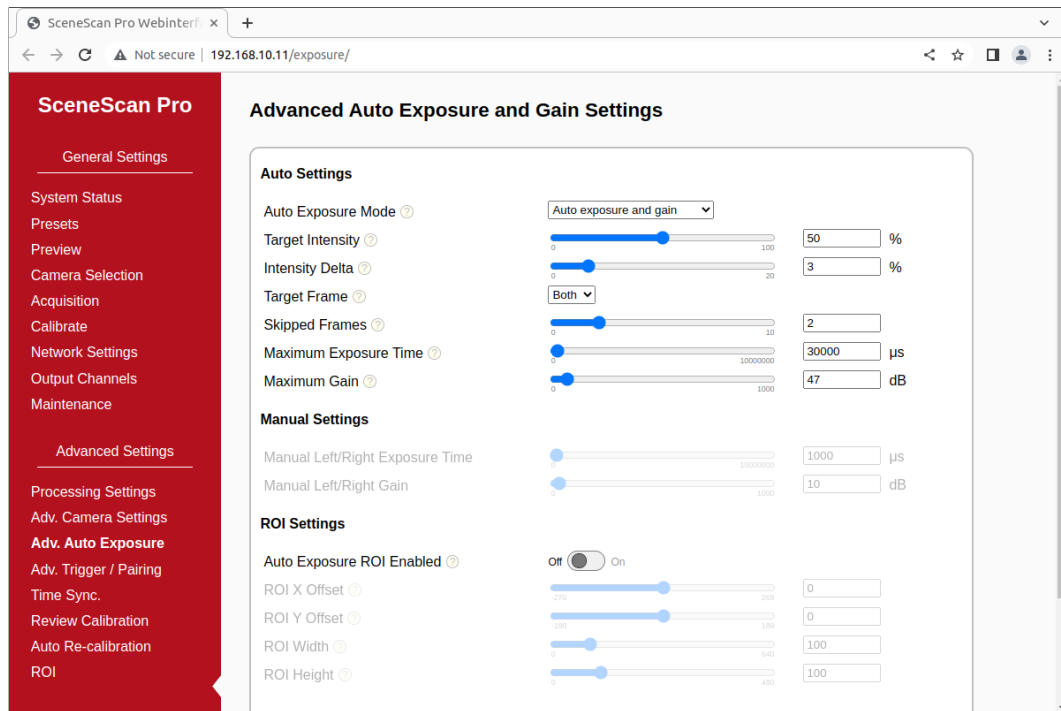

Figure 27: Screenshot of the configuration page for the automatic exposure and gain adjustment settings.

## 9.12 Advanced Auto Exposure and Gain Settings

To ensure the best possible image quality, SceneScan provides a fully automatic exposure time and gain adaptation for rapidly changing lighting conditions, which often occurs in outdoor scenarios. You can activate and deactivate both auto functions independently on the *auto exposure* page, which is shown in Figure 27.

### 9.12.1 Exposure and Gain

**Mode:** Selects whether exposure time and/or gain are adjusted automatically. Under normal circumstances ‘*auto exposure and gain*’ should be selected for the automatic adjustment of both parameters.

**Target intensity:** Selects an average intensity value for the stereo images, which is targeted by the automatic adjustment. Intensity values are written in percentage numbers with 0 representing black and 100 white.

**Intensity delta:** If the average intensity of the image is in the range of *intensity delta* to the *target intensity*, no adjustment is performed, no matter what mode is selected. You can increase the value if you observe flickering in your image stream and decrease it if you need smoother variations between consecutive frames.

**Target frame:** Selects if the intensity of the *left* frame, the intensity of the *right* frame or the average intensity of *both* frames should be adjusted to the *target intensity*.

**Skipped frames:** The number of ignored frames between two adjustment steps. Increase if you want to reach a higher absolute frame rate. As most cameras have a delay between receiving a new parameter and applying it, that value should in general be a positive number and not set to zero.

**Maximum exposure time:** A maximum value for the exposure time can be specified in order to limit motion blur. Depending on your selected frame rate, you might also need to decrease the maximum exposure time to reach the desired rate. The value for the *maximum exposure time* should always be smaller than the time between two frames.

**Maximum gain:** Just like for the exposure time, it is also possible to constrain the maximum allowed gain. Constraining the gain can improve image processing results for situations with high sensor noise.

### 9.12.2 Manual Settings

If the automatic adjustment is deactivated in the *mode* selection, the exposure time and/or gain can be manually set to fixed values in this section.

### 9.12.3 ROI Settings

Rather than performing the adjustment with respect to the average intensity of the complete image, you can compute the average intensity only on a region of interest. Enable ‘*use ROI for adjustment*’ in that case. ‘*Offset X*’ and ‘*Offset Y*’ describe the region’s center position relative to the image center. ‘*Width ROI*’ and ‘*Height ROI*’ let you adjust the spatial extension of the ROI. The ROI must be completely contained in the image. If this is not the case, the ROI will be cropped automatically.

## 9.13 Trigger / Pairing

The ‘*trigger / pairing*’ page that is shown in Figure 28 allows for a configuration of the trigger output and frame pairing settings. Frame pairing refers to the process of identifying which left and right camera frames were recorded at the same time. This is done by comparing the timestamps at which the frames are received by SceneScan against a *maximum time difference*. Only frames whose time stamps do not differ by more than this maximum difference can form an image pair. By default this time difference is automatically determined, but if the *automatic pairing* option is enabled, a manual value can be entered.

If the cameras provide high resolution images or if they have a low pixel transfer speed, it is recommended to increase the maximum time difference.

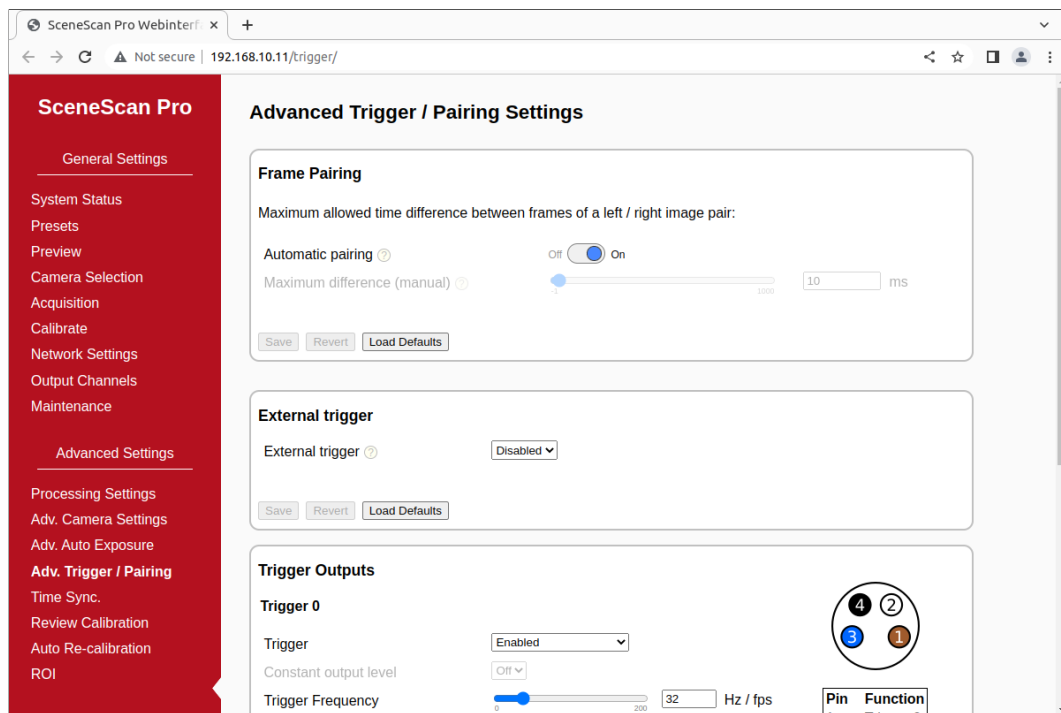

Figure 28: Screenshot of configuration page for trigger settings.

As a general guideline, we recommend setting half of the time delay between two frames as the maximum time difference.

This page also allows for a configuration of SceneScan’s trigger port. As described in Section 7.9, SceneScan features a trigger port that provides access to up to two trigger signals: *Trigger 0* and *Trigger 1*. Typically, a periodic trigger pulse is output on this port. However, if the external software trigger is enabled, a trigger signal can be generated through by software through the API.

The trigger signals can be enabled and disabled individually. When a trigger signal is disabled, it can be specified whether the output should be tied to a *constant on* (logical 1) or *constant off* (logical 0).

For *Trigger 0* it is possible to select a frequency between 0.1 and 200 Hz and an arbitrary pulse width in milliseconds. The polarity of the generated trigger signal can be either active-high or active-low. The pulse width can be constant or cycle between a list of pre-configured values. A cycling pulse width configuration is usually used for high-dynamic-range (HDR) imaging. Some cameras such as Karmin3 have the ability to control the image exposure time through the trigger pulse width, exposing the sensor for as long as the trigger signal is high. If the pulse width cycles between different values, then the cameras’ exposure times will also cycle.

If the checkbox ‘*use trigger time as timestamp*’ is selected, then the trigger time is transmitted as timestamp with each processing result. Please make sure

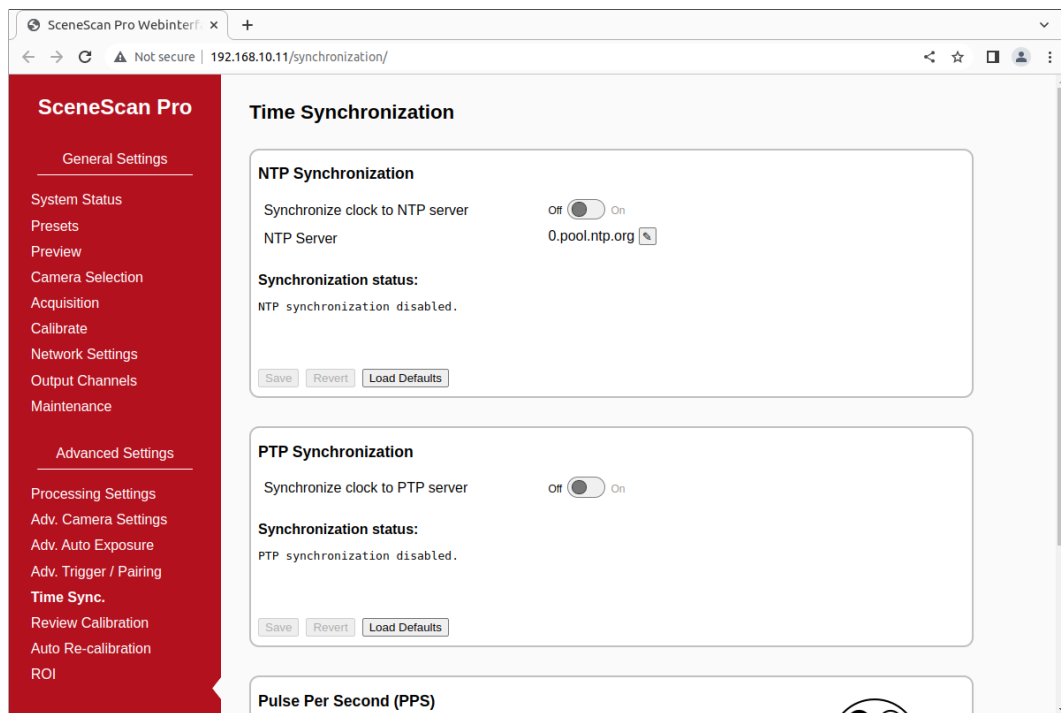

Figure 29: Screenshot of configuration page for time synchronization.

that the cameras do not skip any trigger signals, as in this case the timestamp correlation will fail. This functionality should not be used with virtual cameras such as the hard-coded example and network capturing.

The signal *Trigger 1* can only be enabled if *Trigger 0* is also enabled. The frequency is forced to the same value as for *Trigger 0*. However, it is possible to specify a time offset, which is the delay from a leading edge of *Trigger 0* to a leading edge of *Trigger 1*. Furthermore, *Trigger 1* can have a pulse width and polarity configuration that differs from *Trigger 0*.

## 9.14 Time Synchronization

The ‘*time synchronization*’ page, which is shown in Figure 29, can be used to configure three possible methods for synchronizing SceneScan’s internal clock. As explained in Section 8.4, the internal clock is used for timestamping captured frames.

The first option is to synchronize with a time server, using the Network Time Protocol (NTP) up to version 4. In this case SceneScan synchronizes its internal clock to the given time server, using Coordinated Universal Time (UTC). The accuracy of the time synchronization depends on the latency of your network and time server. If NTP time synchronization is active, synchronization statistics are displayed in a dedicated status area.

As an alternative to NTP, the Precision Time Protocol (PTP) can be used

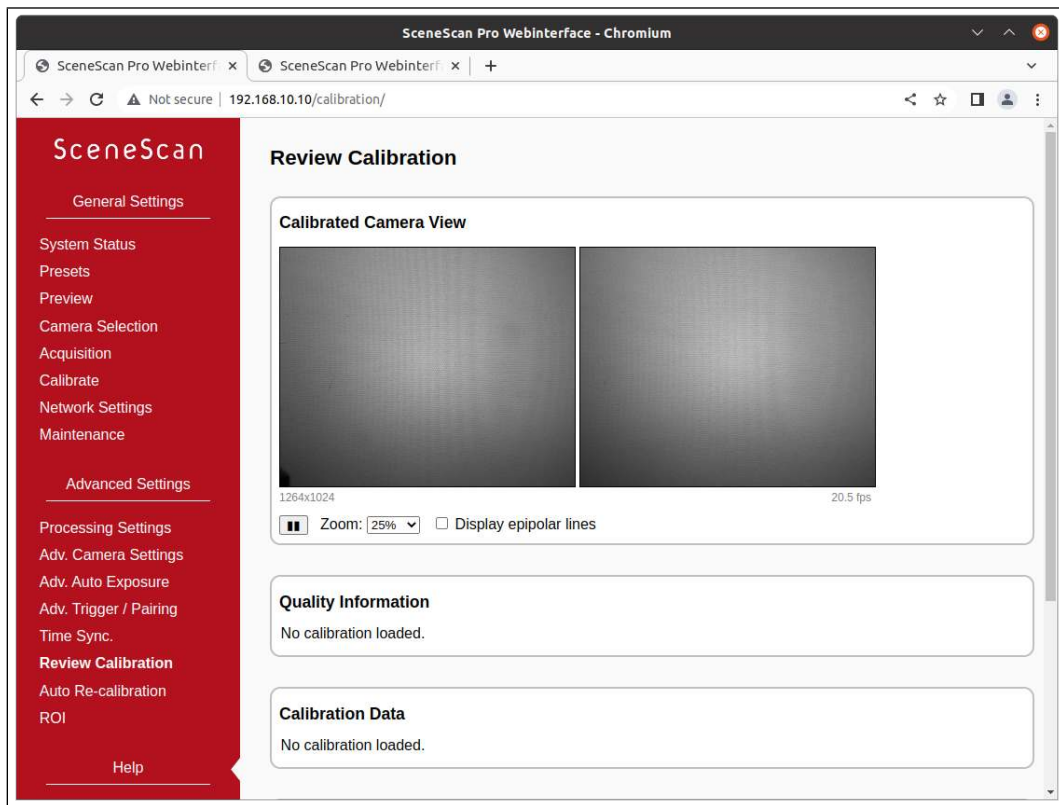

Figure 30: Screenshot of configuration page for reviewing camera calibration.

for synchronization. PTP provides a significantly higher accuracy when compared to NTP, and should hence be preferred if available. Like for NTP, the clock will also be set to UTC and synchronization status information will be displayed.

When using the Pulse Per Second (PPS) signal, the internal clock can be reset to 0 whenever a synchronization signal is received. Alternatively, the the system time stamp for the last received PPS signal can be transmitted with a captured frame. Please refer to Section 7.10 on page 18 for details on the PPS synchronization.

## 9.15 Reviewing Calibration Results

Once calibration has been performed, you can inspect the calibration results on the *'review calibration'* page, which is shown in Figure 30. On the top of this page you can see a live preview of all cameras as they are rectified with the current calibration parameters. Please make sure that corresponding points in the images of all cameras have an identical vertical coordinate.

By activating the *'display epipolar lines'* option, you can overlay a set of horizontal lines on the images. This allows for an easy evaluation of whether

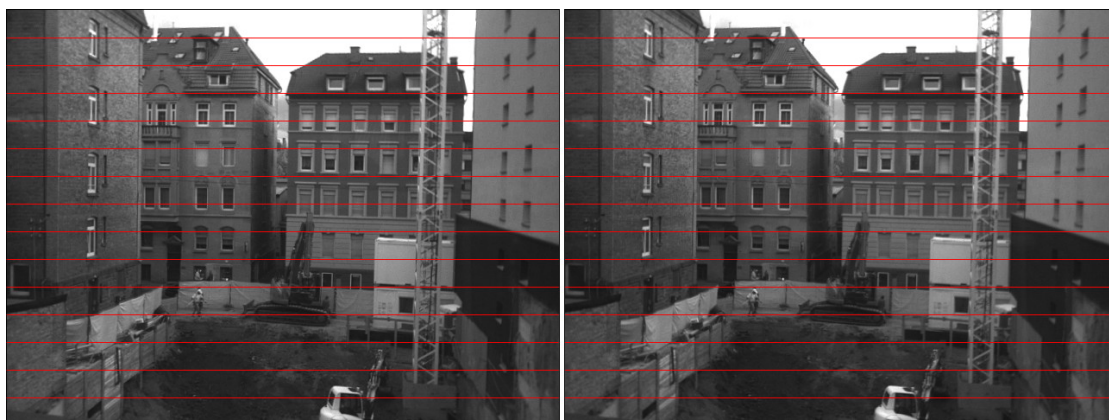

Figure 31: Example for evaluating vertical image coordinates.

the equal vertical coordinates criterion is met. An example for a left and right input image with overlaid epipolar lines is shown in Figure 31.

In the ‘*quality information*’ section you can find the *average reprojection error*. This is a measure for the quality of your calibration, with lower values indicating better calibration results. Please make sure that the average reprojection error is well below 1 pixel.

All computed calibration parameters are displayed in the ‘*calibration data*’ section. These parameters are:

**$M_1$  and  $M_2$ :** camera matrices for the left and right camera.

**$D_1$  and  $D_2$ :** distortion coefficients for the left and right camera.

**$R_1$  and  $R_2$ :** rotation matrices for the rotations between the original and rectified camera images.

**$P_1$  and  $P_2$ :** projection matrices in the new (rectified) coordinate systems.

**$Q_{12}$ :** the disparity-to-depth mapping matrix. See Section 8.2 for its use.

**$T_{12}$ :** translation vector between the coordinate systems of the left and right camera.

**$R_{12}$ :** rotation matrix between the coordinate systems of the left and right camera.

The camera matrices  $M_i$  are structured as follows:

$$M_i = \begin{bmatrix} f_x & 0 & c_x \\ 0 & f_y & c_y \\ 0 & 0 & 1 \end{bmatrix}, \quad (1)$$

where  $f_x$  and  $f_y$  are the lenses’ focal lengths in horizontal and vertical direction (measured in pixels), and  $c_x$  and  $c_y$  are the image coordinates of the projection center.

The distortion coefficient vectors  $D_1$  and  $D_2$  have the following structure:

$$D_i = [k_1 \quad k_2 \quad p_1 \quad p_2 \quad k_3] , \quad (2)$$

where  $k_1$ ,  $k_2$  and  $k_3$  are radial distortion coefficients, and  $p_1$  and  $p_2$  are tangential distortion coefficients.

You can download all calibration information as a machine-readable YAML file, by clicking the download link at the bottom of the ‘*calibration data*’ section. This allows you to easily import the calibration data into your own applications. Furthermore, you can save the calibration data to your PC and reload it at a later time, by using the ‘*upload calibration data*’ section. This allows you to switch between different cameras or optics without repeating the calibration process.

You can also perform a reset of the calibration data by pressing the ‘*reset calibration*’ button. In this case, image rectification is disabled and the unmodified image data is passed on to the stereo matching algorithm. Use this option when selecting the already rectified virtual example camera, as explained in Section 7.8.

## 9.16 Auto Re-calibration

On the ‘*auto re-calibration*’ page, which is shown in Figure 32, you can enable an automated estimation of the calibration parameters. In this case, the system remains calibrated even if the optical alignment is subject to variations. For this process to work, it is necessary that the device has been calibrated once before with the manual calibration procedure (see Section 9.6).

Calibration parameters are usually divided into *intrinsic* parameters (focal length, projection center and distortion coefficients) and *extrinsic* parameters (transformation between the poses of all cameras). Auto re-calibration only performs an update of the extrinsic parameters, as they are significantly more prone to variations. More specifically, only the rotation between the cameras is estimated. This is usually the most fragile parameter, which can be affected significantly by even minor deformations of the camera mount .

Auto re-calibration can be activated by selecting the ‘*enable auto re-calibration*’ option. SceneScan will then continuously compute samples for the estimated inter-camera rotation. A robust estimation method is applied for selecting a final rotation estimate from the set of rotation samples. The *number of samples* that are used for this estimation process can be configured. Small sample sizes allow for a quick reaction on alignment variations, while large sample sizes allow for very accurate estimates. If the ‘*permanently save corrected calibration*’ option is selected, then the updated calibration is written to non-volatile memory and remains present even after a power cycle.

For the auto-calibration to work, the cameras must observe a scene with sufficient visual information. SceneScan will identify salient image features



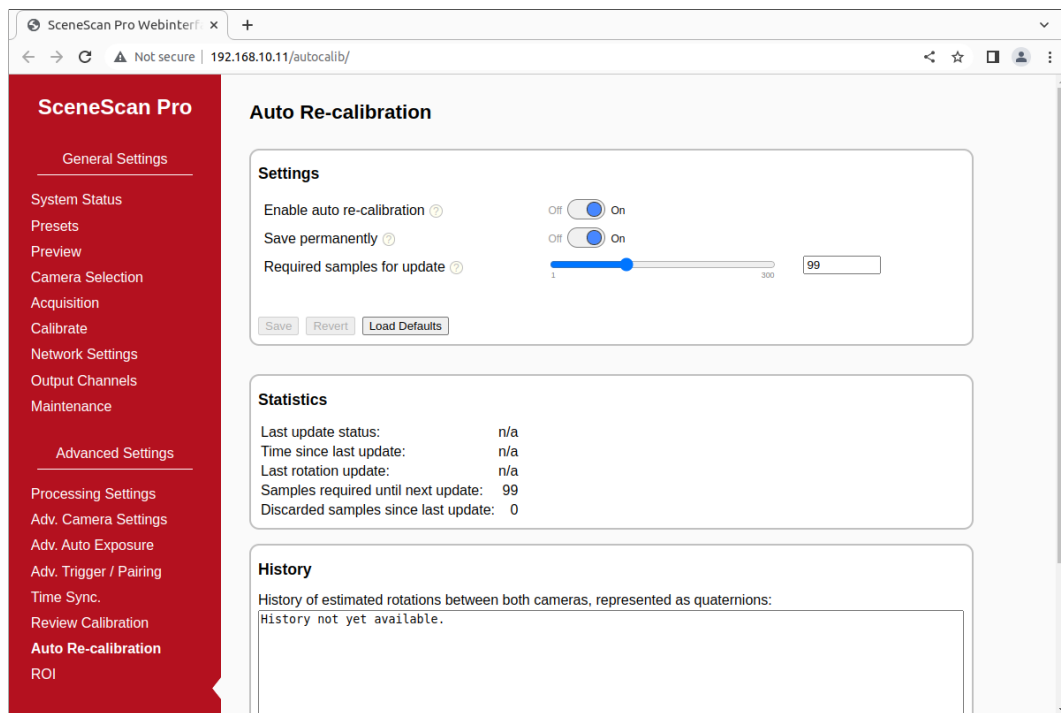

Figure 32: Screenshot of auto re-calibration settings.

and match them across all images. If not enough features can be detected, then auto re-calibration will not run.

In the *statistics* area you can find various information on the current performance of the auto calibration process. This includes the status of the latest re-calibration attempt, the time since the last calibration update, the rotational offset of the last update and the number of rotation samples that have been collected and discarded since the last update. Finally, you can find a list of recently computed inter-camera rotations in the *history* area. The listed rotations are represented as rotation quaternions.

## 9.17 Region of Interest

If not the entire sensor image is needed but only a subsection, then this can be configured on the ‘*region of interest*’ (ROI) page. This page will open a preview of the left and right images with overlaid frames showing the cropped region, which can be moved and resized in unison using the mouse (see Fig. 33). The device will revise the requested ROI dimensions; in this case you will see the region automatically snap to the closest valid image size. It is advised to set the region of interest after first selecting the desired pixel format and then completing calibration.

If calibration was performed on a constrained centered window instead of the full sensor resolution (see Section 9.6), these constrained extents cannot be

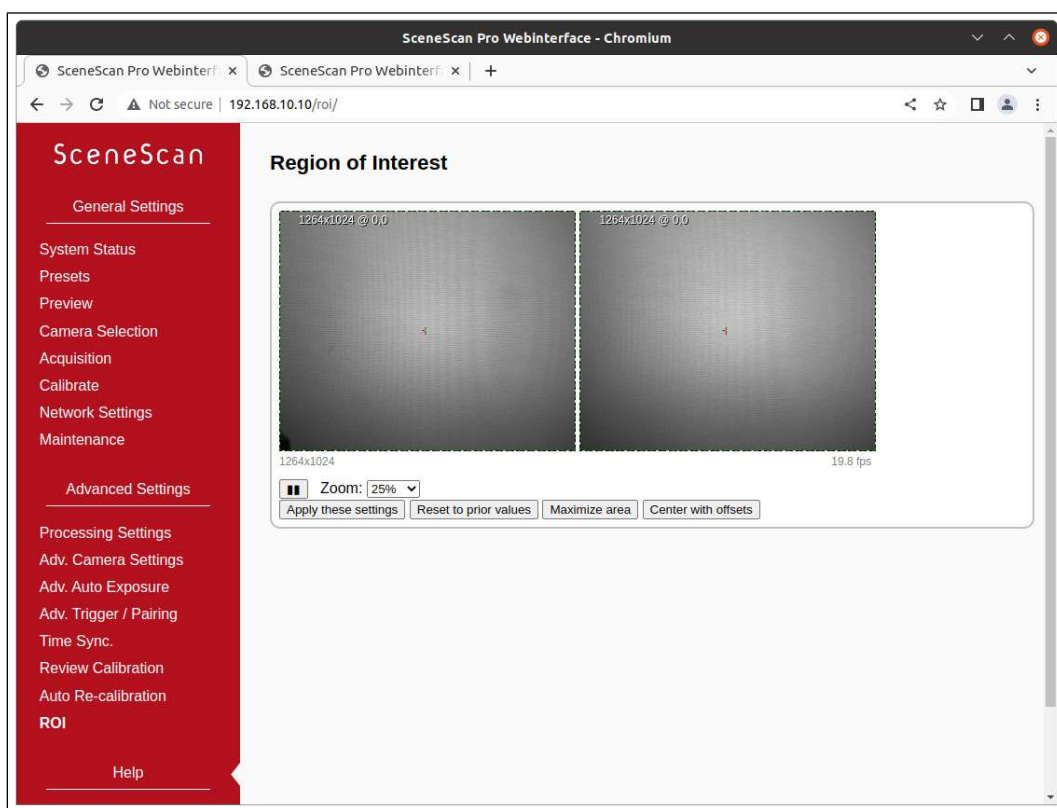

Figure 33: Screenshot of Region-of-Interest selection.

exceeded during ROI selection. The preview image size on the ROI selection page will reflect the constrained calibration-time resolution.

## 10 API Usage Information

### 10.1 General Information

The cross-platform *libvisiontransfer* C++ and Python API is available for interfacing custom software with SceneScan. For Windows, a binary version of the library is available that can be used with Microsoft Visual Studio. For Linux, please compile the library from the available source code. The API is included as part of the available software release, which can be downloaded from our support website<sup>4</sup>.

The *libvisiontransfer* API provides functionality for receiving the processing results of SceneScan over a computer network. Furthermore, the API also allows for the transmission of image data. It can thus be used for emulating SceneScan when performing systems development, or for transmitting image data to SceneScan when using network image input.

<sup>4</sup><https://nerian.com/support/software/>

The transmitted processing results consist of a set of images. Usually these are the rectified left image and the computed disparity map. If configured, however, SceneScan can also provide the raw recorded images or all rectified images (see Section 9.10).

Original and rectified camera images are typically transmitted with a monochrome bit-depth of 8 bits or 12 bits per pixel, or in 8-bit RGB mode. The disparity map is always transmitted with a bit depth of 12 bits. Inside the library, the disparity map and any 12-bit images are inflated to 16 bits, to allow for more efficient processing.

The API provides three classes that can be used for receiving and transmitting image data:

- `ImageProtocol` is the most low-level interface. This class allows for the encoding and decoding of image sets to / from network messages. You will have to handle all network communication yourself.
- `ImageTransfer` opens up a network socket for sending and receiving image sets. This class is single-threaded and will thus block when receiving or transmitting data.
- `AsyncTransfer` allows for the asynchronous reception or transmission of image sets. This class creates one or more threads that handle all network communication.

Detailed information on the usage of each class can be found in the available API documentation.

## 10.2 ImageTransfer Example

An example for using the class `ImageTransfer` in C++ to receive processing results over the network, and writing them to image files, is shown below. This source code file is part of the API source code release. Please refer to the API documentation for further information on using `ImageTransfer` and for examples in Python.

```
#include <visiontransfer/deviceenumeration.h>
#include <visiontransfer/imagetransfer.h>
#include <visiontransfer/imageset.h>
#include <iostream>
#include <exception>
#include <stdio.h>

#ifdef _MSC_VER
// Visual studio does not come with snprintf
#define snprintf _snprintf_s
#endif
```

```

using namespace visiontransfer;

/*
 * NOTE: The use of ImageTransfer is only advised when operation
 * without background threads is strictly required. For typical
 * application use, we recommend to use AsyncTransfer instead
 * (see asynctransfer_example.cpp).
 *
 * When using ImageTransfer directly, make sure to regularly poll
 * using receiveImageSet(); i.e. limit the frame rate through
 * the device settings, and not by reducing call frequency.
 */

int main() {
    // Search for Nerian stereo devices
    DeviceEnumeration deviceEnum;
    DeviceEnumeration::DeviceList devices =
        deviceEnum.discoverDevices();
    if(devices.size() == 0) {
        std::cout << "No devices discovered!" << std::endl;
        return -1;
    }

    // Print devices
    std::cout << "Discovered devices:" << std::endl;
    for(unsigned int i = 0; i < devices.size(); i++) {
        std::cout << devices[i].toString() << std::endl;
    }
    std::cout << std::endl;

    // Create an image transfer object that receives data from
    // the first detected device
    ImageTransfer imageTransfer(devices[0]);

    // Receive 100 images
    for(int imgNum=0; imgNum<100; imgNum++) {
        std::cout << "Receiving image set" << imgNum << std::endl;

        // Receive image
        ImageSet imageSet;
        while(!imageTransfer.receiveImageSet(imageSet)) {
            // Keep on trying until reception is successful
        }

        // Write all included images one after another
        for(int i = 0; i < imageSet.getNumberOfImages(); i++) {
            // Create PGM file
            char fileName[100];
            snprintf(fileName, sizeof(fileName), "image%03d_%d.pgm", imgNum, i);
            imageSet.writePgmFile(i, fileName);
        }
    }
}

```

```
    return 0;
}
```

### 10.3 AsyncTransfer Example

An example for using the class `AsyncTransfer` in C++ to receive processing results over the network, and writing them to image files, is shown below. This source code file is part of the API source code release. Please refer to the API documentation for further information on using `AsyncTransfer` and for examples in Python.

```
#include <visiontransfer/deviceenumeration.h>
#include <visiontransfer/asynctransfer.h>
#include <visiontransfer/imageset.h>
#include <iostream>
#include <exception>
#include <stdio.h>

#ifdef _MSC_VER
// Visual studio does not come with snprintf
#define snprintf _snprintf_s
#endif

using namespace visiontransfer;

int main() {
    try {
        // Search for Nerian stereo devices
        DeviceEnumeration deviceEnum;
        DeviceEnumeration::DeviceList devices =
            deviceEnum.discoverDevices();
        if(devices.size() == 0) {
            std::cout << "No devices discovered!" << std::endl;
            return -1;
        }

        // Print devices
        std::cout << "Discovered devices:" << std::endl;
        for(unsigned int i = 0; i < devices.size(); i++) {
            std::cout << devices[i].toString() << std::endl;
        }
        std::cout << std::endl;

        // Create an image transfer object that receives data from
        // the first detected device
        AsyncTransfer asyncTransfer(devices[0]);

        // Receive 100 images
        for(int imgNum=0; imgNum<100; imgNum++) {
            std::cout << "Receiving image set" << imgNum << std::endl;

```

```

// Receive image
ImageSet imageSet;
while(!asyncTransfer.collectReceivedImageSet(imageSet,
    0.1 /*timeout*/) {
    // Keep on trying until reception is successful
}

// Write all included images one after another
for(int i = 0; i < imageSet.getNumberOfImages(); i++) {
    // Create PGM file
    char fileName[100];
    snprintf(fileName, sizeof(fileName), "image%03d_%d.pgm", imgNum, i);
    imageSet.writePgmFile(i, fileName);
}
}
} catch(const std::exception& ex) {
    std::cerr << "Exception occurred: " << ex.what() << std::endl;
}

return 0;
}

```

## 10.4 3D Reconstruction

As described in Section 8.2, the disparity map can be transformed into a set of 3D points. This requires knowledge of the disparity-to-depth mapping matrix  $Q$  (see Section 8.2), which is transmitted by SceneScan along with each disparity map.

An optimized implementation of the required transformation, which uses the SSE or AVX instruction sets, is provided by the API through the class `Reconstruct3D`. This class converts a disparity map into a map of 3D point coordinates. Please see the API documentation for further details.

## 10.5 Parameters

A separate network protocol is used for reading and writing device parameters. This protocol is implemented by `DeviceParameters`. Any parameters that are changed through this protocol will be reset if the device is rebooted or if the user makes a parameter change through the web interface.

# 11 Supplied Software

## 11.1 NVCom

The available source code or binary software release also includes the NVCom client application, which is shown in Figure 34. When compiling this appli-

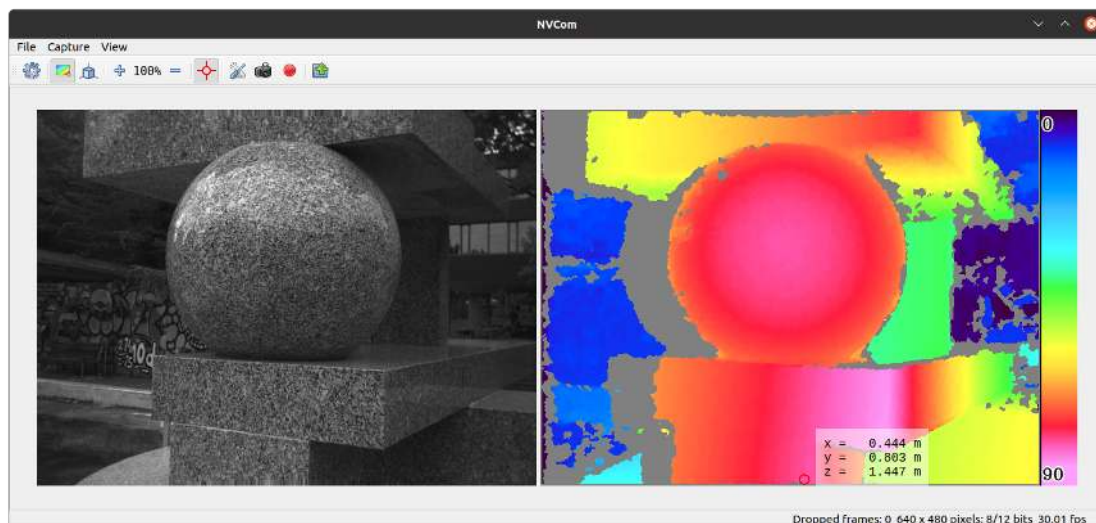

Figure 34: Screenshot of NVCom application.

cation yourself, please make sure that you have the libraries OpenCV and Qt installed. NVCom provides the following features:

- Discover SceneScan devices, view their status, and access their setup.
- Receive and display images and disparity maps from SceneScan.
- Perform color-coding of disparity maps.
- Provide live 3D pointcloud visualization.
- Write received data to files as images or 3D point clouds.
- Transmit input images to SceneScan.

NVCom comes with a GUI that provides access to all important functions. More advanced features are available through the command line options, which are listed in Table 3. The command line options can also be used for automating data recording or playback.

Unless NVCom is run in non-graphical mode, it opens a GUI window that displays the received images. The currently displayed image set can be written to disk by pressing the *enter* key or by clicking the camera icon in the toolbar. When pressing the *space* key or clicking the recording icon, all subsequent images will be saved. When closing NVCom it will save its current settings, which will be automatically re-loaded when NVCom is launched the next time.

## 11.2 GenICam GenTL Producer

### 11.2.1 Installation

The available software release further includes a software module that complies to the GenICam GenTL standard. The GenTL standard specifies a generic

Table 3: Available command line options for NvCom.

<code>-c VAL</code>	Select color coding scheme (0 = no color, 1 = red / blue, 2 = rainbow)
<code>-f FPS</code>	Limit send frame rate to FPS
<code>-w DIR</code>	Immediately write all images to DIR
<code>-s DIR</code>	Send the images from the given directory
<code>-n</code> Non-graphical	
<code>-p PORT</code>	Use the given remote port number for communication
<code>-H HOST</code>	Use the given remote hostname for communication
<code>-t on/off</code>	Activate / deactivate TCP transfers
<code>-d</code>	Disable image reception
<code>-T</code>	Print frame timestamps
<code>-3 VAL</code>	Write a 3D point cloud with distances up to VAL (0 = off)
<code>-z VAL</code>	Set zoom factor to VAL percent
<code>-F</code>	Run in fullscreen mode
<code>-b on/off</code>	Write point clouds in binary rather than text format
<code>-h, -help</code>	Displays this help.

transport layer interface for accessing cameras and other imaging devices. According to the GenICam naming convention, a GenTL producer is a software driver that provides access to an imaging device through the GenTL interface. A GenTL consumer, on the other hand, is any software that uses one or more GenTL producers through this interface. The supplied software module represents a GenTL producer and can be used with any application software that acts as a consumer. This allows for the ready integration of SceneScan into existing machine vision software suites like e.g. HALCON.

Depending on the version that you downloaded, the producer is provided either as a binary or as source code. If you choose the source code release, the producer will be built along with the other software components. The produced / downloaded binary is named `nerian-gentl.cti`. In order to be found by a consumer, this file has to be placed in a directory that is in the GenTL search path. The search path is specified through the following two environment variables:

`GENICAM_GENTL32_PATH`: Search path for 32-bit GenTL producers.  
`GENICAM_GENTL64_PATH`: Search path for 64-bit GenTL producers.

The binary Windows installer automatically configures these environment variables. When building the source code release, please configure the environment variables manually.



### 11.2.2 Virtual Devices

Once the search path has been set, the producer is ready to be used by a consumer. For each SceneScan the producer provides five *virtual devices*, which each deliver one part of the obtained data. These virtual devices are named as follows:

- /left** Provides the left camera image that is transmitted by SceneScan. In the default configuration, this is the image after rectification has been applied. In monochrome mode, the image is encoded with 8 or 12 bits per pixel (Mono8 or Mono12), and as RGB image with 8 bits per channel (RGB8) for color mode.
- /right** Provides the right camera image. This image might not be transmitted depending on the device configuration. The image is encoded in Mono8, Mono12 or RGB8 format.
- /disparity** Provides the disparity map that is transmitted by SceneScan. This data is not available if SceneScan is configured in pass through or rectify mode. The disparity map is transmitted with a non-packed 12 bits per pixel encoding (Mono12).
- /pointcloud** Provides a transformation of the disparity map into a 3D point cloud (see Section 8.2). Each point is represented by three 32-bit floating point numbers that encode an x-, y- and z-coordinate (Coord3D\_ABC32f).
- /** This virtual device provides a multi-part data stream which contains all the data that is available through the other devices. In the default configuration, this device provides the left camera image, the disparity map and the 3D point cloud.

The virtual devices */left*, */right* and */disparity* deliver the unprocessed data that is received from SceneScan. The data obtained through the */pointcloud* device is computed by the producer from the received disparity map. This is done by multiplying the disparity map with the disparity-to-depth mapping matrix  $Q$  (see Section 8.2), which is transmitted by SceneScan along with each image pair. Invalid disparities are set to the minimum disparity and thus result in points with very large distances.

It is recommended to use the multi-part virtual device */* when more than one type of data is required. This will guarantee that all data acquisition is synchronized. When requiring only one type of input data, then using the dedicated virtual devices is the most efficient option.

### 11.2.3 Device IDs

All device IDs that are assigned by the producer are URLs and consist of the following components:

```
protocol://address/virtual device
```

The *protocol* component identifies the underlying transport protocol that shall be used for communication. The following values are possible:

**udp:** Use the connection-less UDP transport protocol for communication.

**tcp:** Use the connection oriented TCP transport protocol for communication.

The *virtual device* shall be set to one of the device names that have been listed in the previous section. Some examples for valid device IDs are:

```
udp://192.168.10.10/pointcloud
tcp://192.168.10.100/left
```

## 11.3 ROS Node

For integrating SceneScan with the Robot Operating System (ROS), there exists an official ROS node. This node is called `nerian_stereo` and can be found in the official ROS package repository. The node publishes the computed disparity map and the corresponding 3D point cloud as ROS topics. Furthermore, it can publish camera calibration information.

To install this node from the ROS package servers on a Ubuntu Linux system, please use the following commands:

```
> sudo apt-get update
> sudo apt-get install ros-rosversion -d'-nerian-stereo
```

Detailed information on this node can be found on the corresponding ROS wiki page<sup>5</sup>.

## 12 Support

If you require support with using SceneScan then please contact our support team at <https://www.alliedvision.com/en/about-us/contact-us/technical-support-repair-/-rma/>

---

<sup>5</sup>[http://wiki.ros.org/nerian\\_stereo](http://wiki.ros.org/nerian_stereo)

## 13 Warranty Information

The device is provided with a 2-year warranty according to German federal law (BGB). Warranty is lost if:

- the housing is opened by others than official Allied Vision service staff.
- the firmware is modified or replaced, except for official firmware updates.

In case of warranty please contact our support staff.

## 14 Open Source Information

SceneScan's firmware contains code from the open source libraries and applications listed in Table 4. Source code for these software components and the wording of the respective software licenses can be obtained from the open source information website<sup>6</sup>. Some of these components may contain code from other open source projects, which may not be listed here. For a definitive list, please consult the respective source packages.

The following organizations and individuals have contributed to the various open source components:

Free Software Foundation Inc., Emmanuel Pacaud, EMVA and contributors, The Android Open Source Project, Red Hat Incorporated, University of California, Berkeley, David M. Gay, Christopher G. Demetriou, Royal Institute of Technology, Alexey Zelkin, Andrey A. Chernov, FreeBSD, S.L. Moshier, Citrus Project, Todd C. Miller, DJ Delorie, Intel Corporation, Henry Spencer, Mike Barcroft, Konstantin Chuguev, Artem Bityuckiy, IBM, Sony, Toshiba, Alex Tatmanjants, M. Warner Losh, Andrey A. Chernov, Daniel Eischen, Jon Beniston, ARM Ltd, CodeSourcery Inc, MIPS Technologies Inc, Intel Corporation, Willow Garage Inc., NVIDIA Corporation, Advanced Micro Devices Inc., OpenCV Foundation, Itseez Inc., The Independent JPEG Group, elibThomas G. Lane, Guido Vollbeding, Simon-Pierre Cadieux, Eric S. Raymond, Mans Rullgard, Cosmin Truta, Gilles Vollant, James Yu, Tom Lane, Glenn Randers-Pehrson, Willem van Schaik, John Bowler, Kevin Bracey, Sam Bushell, Magnus Holmgren, Greg Roelofs, Tom Tanner, Andreas Dilger, Dave Martindale, Guy Eric Schalnat, Paul Schmidt, Tim Wegner, Sam Leffler, Silicon Graphics, Inc. Industrial Light & Magic, University of Delaware, Martin Burnicki, Harlan Stenn, Danny Mayer, The PHP Group, OpenSSL Software Services, Inc., OpenSSL Software Foundation, Inc., Andy Polyakov, Ben Laurie, Ben Kaduk, Bernd Edlinger, Bodo Möller, David Benjamin, Emilia Käsper, Eric Young, Geoff Thorpe, Holger Reif, Kurt Roeckx, Lutz Jänicke, Mark J. Cox, Matt Caswell, Matthias St. Pierre, Nils Larsch, Paul Dale, Paul C. Sutton, Ralf S. Engelschall, Rich Salz, Richard Levitte, Stephen Henson, Steve Marquess, Tim Hudson, Ulf Möller, Viktor Dukhovni

All authors contributing to packages included in PetaLinux. Please obtain the full list from [www.xilinx.com/petalinux](http://www.xilinx.com/petalinux).

If you believe that your name should be included in this list, then please let us know.

---

<sup>6</sup><http://nerian.com/support/resources/scenescan-open-source/>

Table 4: Open source components.

<b>Name</b>	<b>Version</b>	<b>License(s)</b>
Aravis	0.6.4 patched	GNU LGPL 2.0
GenApi reference implementation	3.1.0	GenICam License
libgpiod	1.4	GNU LGPL 2.1
libwebsockets	2.2	GNU LGPL 2.1
Linux PTP	3.1	GNU GPL 2
ntp	4.2.8p10	BSD License MIT License
OpenCV	3.2.0	BSD License libpng License JasPer License 2.0
OpenSSL	1.1.1d	BSD License
PetaLinux	2019.2	Various
PHP	7.3.7	PHP License

## Revision History

Revision	Date	Author(s)	Description
v1.18	March 15, 2024	KS	Renamed document to user guide
v1.17	August 25, 2023	KS	Rebranding from Nerian Vision to Allied Vision
v1.16	December 9, 2022	KS	Output channels configuration
v1.15	July 30, 2022	KS	Updated for firmware 9.0
v1.14	March 30, 2021	KS	Updated performance specifications for firmware 8.0
v1.13	November 20, 2020	KS, RYT	Chapter on lens focusing; constrained ROI calibration; minor extensions / corrections.
v1.12	October 13, 2020	KS	Updated frame rate recommendations.
v1.11	Sept 16, 2020	KS	New constant on/off trigger output modes.
v1.10	July 29, 2020	KS	Description of new setting: maximum result set size.
v1.9	July 1, 2020	KS	New simple and advanced settings. New Acquisition configuration page.
v1.8	January 20, 2020	RYT, KS	ROI selection; trigger pulse width cycling
v1.7	November 20, 2019	RYT, KS	DHCP support; improved sub-pixel optimization.
v1.6	August 14, 2019	KS	Updated specifications for firmware 4.0.0; Add Karmin3 information.
v1.5.1	July 23, 2019	KS	Minor corrections.
v1.5	April 1, 2019	KS	Support for Bayer pattern inputs.
v1.4	November 30, 2018	KS	Added new support for color image processing; added Baumer cameras. Minor wording improvements.
v1.3	June 7, 2018	KS	Changes for vision software release 6.0.0 / firmware release 2.0.0
v1.2	March 1, 2018	KS	Added PTP synchronization
v1.1	February 1, 2018	JH, KS	Auto exposure; frame rate table; supported pixel formats.
v1.0	September 27, 2017	KS	Initial revision